

JVC

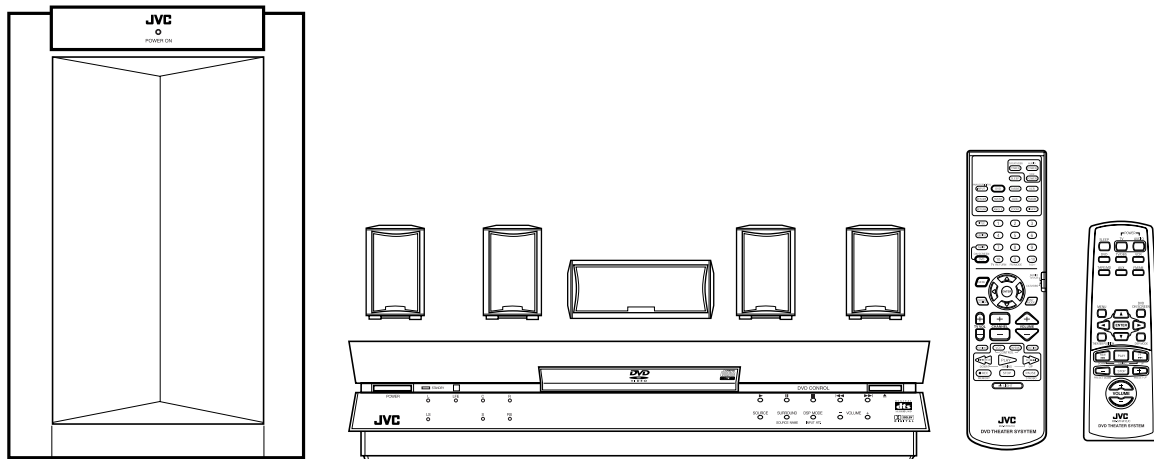

DVD DIGITAL THEATER SYSTEM

TH-A10



AV COMPU LINK

INSTRUCTIONS

For Customer Use:

Enter below the Model No. and Serial No. which are located either on the rear, bottom or side of the cabinet. Retain this information for future reference.

Model No. _____

Serial No. _____

LVT0457-001A

[J]

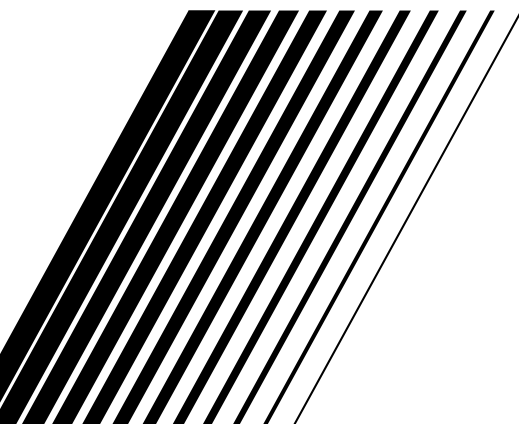

Warnings, Cautions and Others

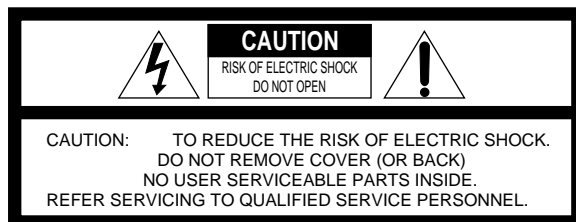

The lightning flash with arrowhead symbol, within an equilateral triangle is intended to alert the user to the presence of uninsulated "dangerous voltage" within the product's enclosure that may be of sufficient magnitude to constitute a risk of electric shock to persons.



The exclamation point within an equilateral triangle is intended to alert the user to the presence of important operating and maintenance (servicing) instructions in the literature accompanying the appliance.

For U.S.A.

This equipment has been tested and found to comply with the limits for a Class B digital device, pursuant to part 15 of the FCC Rules. These limits are designed to provide reasonable protection against harmful interference in a residential installation.

This equipment generates, uses and can radiate radio frequency energy and, if not installed and used in accordance with the instructions, may cause harmful interference to radio communications. However, there is no guarantee that interference will not occur in a particular installation. If this equipment does cause harmful interference to radio or television reception, which can be determined by turning the equipment off and on, the user is encouraged to try to correct the interference by one or more of the following measures:

Reorient or relocate the receiving antenna.

Increase the separation between the equipment and receiver.

Connect the equipment into an outlet on a circuit different from that to which the receiver is connected.

Consult the dealer or an experienced radio/TV technician for help.

WARNING: TO REDUCE THE RISK OF FIRE OR ELECTRIC SHOCK, DO NOT EXPOSE THIS APPLIANCE TO RAIN OR MOISTURE.

Caution — POWER switch!

Disconnect the mains plug to shut the power off completely. The POWER switch in any position does not disconnect the mains line. The power can be remote controlled.

IMPORTANT FOR LASER PRODUCTS

1. CLASS 1 LASER PRODUCT
2. **DANGER:** Visible laser radiation when open and interlock failed or defeated. Avoid direct exposure to beam.
3. **CAUTION:** Do not open the top cover. There are no user serviceable parts inside the Unit; leave all servicing to qualified service personnel.

CAUTION

To reduce the risk of electrical shocks, fire, etc.:

1. Do not remove screws, covers or cabinet.
2. Do not expose this appliance to rain or moisture.

Table of Contents

Getting Started	2	Changing the audio language or sound [AUDIO]	30
Important cautions	2	Changing the audio channel [AUDIO]	30
Safety precautions	2	Viewing from Multiple Angles [ANGLE]	31
Checking the supplied accessories	2	Selecting the Picture Character [THEATER POSITION]	32
System outline	3	Repeating a current title, chapter or track, or all tracks [REPEAT]	32
Installation	4	Repeating a desired part [A-B REPEAT]	33
To attach non-slip rubbers to the center speaker	4	Sampling all tracks [INTRO]	33
To hang satellite speakers from the wall	4	Checking the Disc Time [TIME SELECT]	34
About discs	5	Programming the Playing Order of the Tracks [PROGRAM]	34
Playable disc types	5	Random Play [RANDOM]	35
Disc structure	5	Receiving radio broadcasts	36
Video CDs with Playback Control function	5	Tuning in stations manually	36
Connections	6	Using preset tuning	36
Connecting the FM and AM antennas	6	Selecting the FM reception mode	37
To connect the powered sub-woofer	6	Beat cut	37
Connecting the TV	6	Performing miscellaneous settings	38
To connect speakers	7	AV amplifier settings on-screen display	38
Connecting Audio/Video Components	8	DVD settings on-screen display	38
Connecting the power cord	10	MAIN MENU Settings	39
Putting batteries in the remote control	10	Opening the MAIN MENU	39
Parts Identification	11	ON SCREEN LANGUAGE	39
Principles of operation	13	Setting the SLEEP TIMER	39
Operation with the remote control	13	Changing the DECODE MODE	40
To operate via the on-screen menu	14	Changing the DSP MODE	40
Preventing screen burn-out with the screen saver [SCREEN SAVER]	15	Adjusting the volume	40
Basic operations	16	SOUND MENU Settings	41
To turn the system power supply ON and OFF (standby)	16	Opening the SOUND MENU	41
To turn TV power ON and OFF	16	Adjusting the balance	41
Adjusting volume	16	Using loudness	41
Muting the sound	17	Adjusting input signal	42
Selecting the source to play	17	Adjusting the sub-woofer output level	42
Changing the source name	17	Adjusting the dynamic range	42
Selecting the analog or digital input mode	18	Adjusting the DSP effect	42
Changing the decode mode	18	SPEAKER MENU Settings	43
Adjusting the Input Signal Level	19	Opening the SPEAKER MENU	43
Sub-woofer volume control and phase setting	19	Switching speaker mode	43
Audio channel display lamp	19	Playing a test tone	44
Using the Sleep Timer	20	Setting speaker size	44
Using the DSP Modes	20	Setting speaker level	45
Using the DVD player	22	Adjusting delay time	45
To play a disc	22	DVD MENU Settings	46
Pausing	23	Opening the DVD MENU	46
Fast forward and rewind	23	Choosing menu language	46
Locating the beginning	23	Choosing audio language	47
Resuming playback	24	Choosing subtitle language	47
Selecting playback from the DVD menu	24	On-screen guide settings	47
Selecting the location to view from the video CD menu	25	Select monitor type	48
To specify the title or track number for playback	25	Screen saver settings	48
To play from the beginning of a title, chapter, or track	26	Limiting playback by children	49
To specify the chapter number for playback [CHAP. SEARCH]	26	To set Parental Lock for the first time [PARENTAL LOCK]	49
To specify the time for playback [TIME SEARCH]	26	To temporarily release the Parental lock	50
To select the screen for playback from the digest screen [DIGEST]	27	Care and handling of discs	51
To advance the picture one frame at a time	28	How to handle discs	51
Slow-Motion Playback [SLOW]	28	AV COMPU LINK Remote Control System	52
To display Continuous Photos [STROBE]	28	COMPU LINK Remote Control System	54
Zooming a scene [ZOOM]	29	Operating JVC's Audio/Video Components	55
Changing the Subtitle Language [SUB TITLE]	29	Operating Other Manufacturers' Video Equipment	57
		Troubleshooting	59
		Specifications	60

Getting Started

Important cautions

Installation of the unit

- Select a place which is level, dry and neither too hot nor too cold between 5°C and 35°C (41°F and 95°F).
- Leave sufficient distance between the unit and the TV.
- Do not use the unit in a place subject to vibrations.

Power cord

- Do not handle the power cord with wet hands!
- A small amount of power (3 watts) is always consumed while the power cord is connected to the wall outlet.
- When unplugging the unit from the wall outlet, always pull the plug, not the power cord.

To prevent malfunction of the unit

- There are no user-serviceable parts inside. If anything goes wrong, unplug the power cord and consult your dealer.
- Do not insert any metallic object into the unit.
- Do not use any non-standard shape disc available on the market, because it may damage the unit.
- Do not use a disc with tape, seals, or paste on it, because damage to the unit may result.

Note about copyright laws

- Please check the copyright laws in your country before recording from DVD VIDEO, Audio CD, and Video CD discs. Recording of copyrighted material may infringe copyright laws.

Note about the copyguard system

- The DVD VIDEO disc is protected by the copyguard system. When you connect the unit to your VCR directly, the copyguard system activates and the picture may not be played back correctly.

Safety precautions

Avoid moisture, water and dust

Do not place your unit in moist or dusty places.

Avoid high temperatures

Do not expose the unit to direct sunlight or place it near a heating device.

When you're away

When away on travel or otherwise for an extended period of time, remove the plug from the wall outlet.

Do not block the vents

Blocking the vents may damage the unit.

Care of the cabinet

When cleaning the unit, use a soft cloth and follow the relevant instructions on the use of chemically-coated cloths. Do not use benzene, thinner or other organic solvents and disinfectants. These may cause deformation or discoloring.

If water gets inside the unit

Turn off the power switch and remove the plug from the wall outlet, then call the store where you made your purchase. Using the unit in this state may cause a fire or electrical shock.

Checking the supplied accessories

Check to be sure you have all of the following items, which are supplied with the unit.

The number in the parentheses indicates quantity of the pieces supplied.



Primary remote control (1)



Secondary remote control (1)

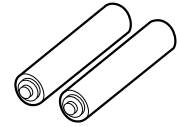

Batteries (4)

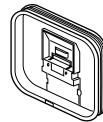

AM Loop Antenna (1)

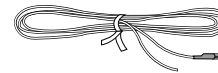

FM Antenna (1)

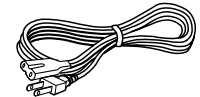

AC Power Cord (1)



Video Cable (1)

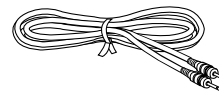

Compulink Cord (1)



System Cable (1)

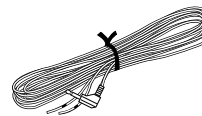

Speaker Cord 6 m (19.7 ft) (3)

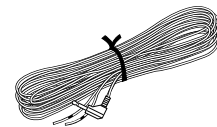

Speaker Cord 15m (49.2 ft) (2)

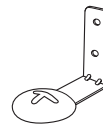

Satellite speaker wall bracket (4)



Screws (4)



Non-slip rubbers (3)

System outline

This system consists of the center unit containing a DVD player, a radio, and a pre-amp, as well as the powered sub-woofer, the center speaker, and four satellite speaker units. It provides a fully functional DVD theater system by simply connecting to a TV set.

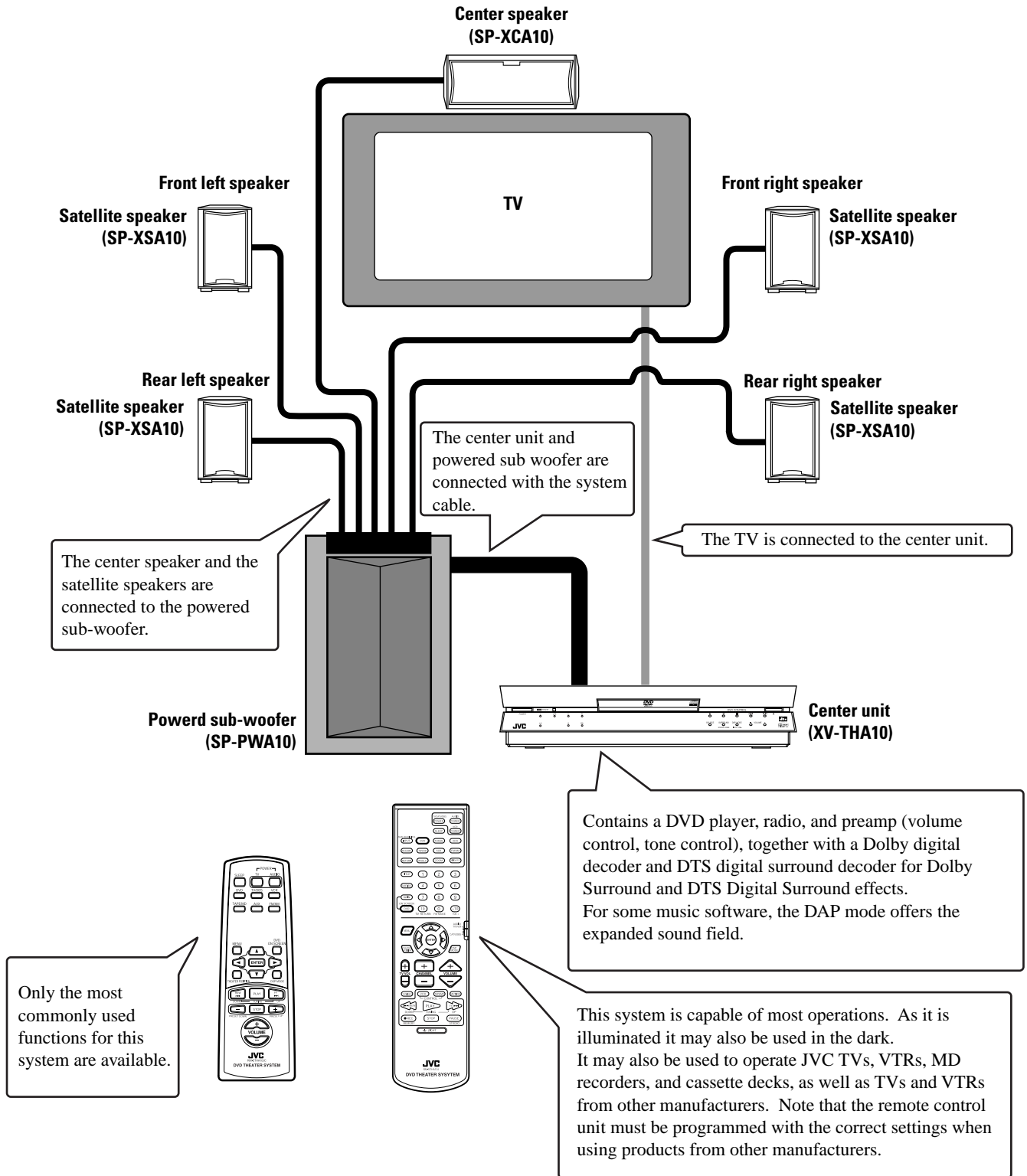

Installation

To attach non-slip rubbers to the center speaker

Attach the supplied non-slip rubbers at three points on the bottom of the center speaker.

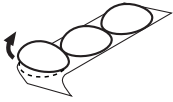

The non-slip rubbers are adhesive. Peel off the seal before applying.

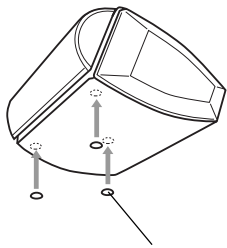

Attach non-slip rubbers at the three points shown in the diagram. Attach two rubbers at left and right at the front of the speaker, and one in the middle at the rear.

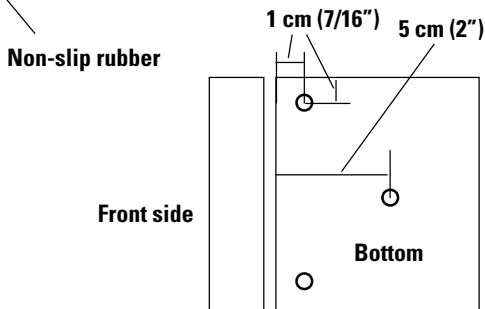

Example

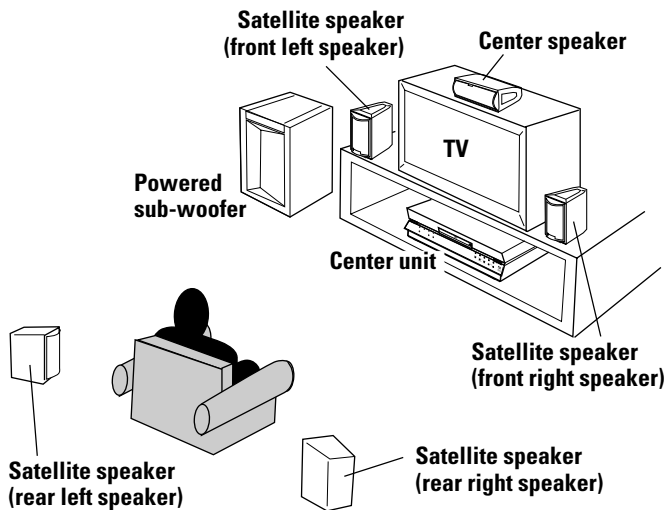

The rear speakers are placed behind the listening position.

CAUTIONS:

- For safety reasons, always ensure that there is sufficient place behind the powered sub-woofer.
- If the front and rear speakers are placed on the floor, always ensure that they are level.

To hang satellite speakers from the wall

Use the supplied bracket to fix satellite speakers to the wall.

CAUTION: ATTACHING THE BRACKETS ON THE WALL

When attaching the brackets on the wall, have them attached to the wall by a qualified person.

DO NOT attach the brackets on the wall by yourself to avoid an unexpected damage of their falling from the wall, caused by incorrect attachment or weakness in the wall.

Location of attachment to wall:

Care is required in selecting a location for attaching satellite speakers to the wall. Injury to personnel, or damage to equipment, may result if the speakers are attached in a location which interferes with daily activities.

Attaching speakers to the bracket

1. Use the screw supplied to attach the speaker to the bracket.

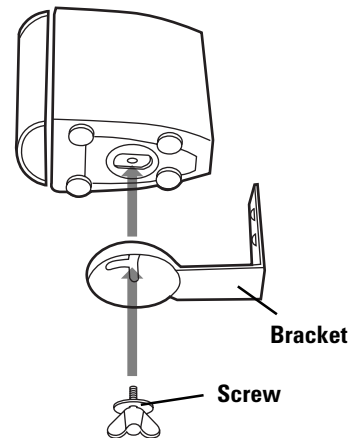

2. Adjusting the angle of the satellite speakers

The angle of the speaker may be adjusted in the front-rear and left-right directions along the channel in the bracket.

When adjusting the angle, loosen the screw slightly, make the adjustment, and then tighten the screw firmly.

Tilting the speaker to the front

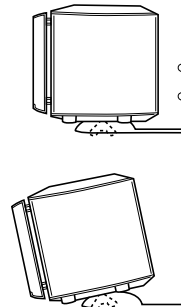

CAUTION:
If the screw is not tightened firmly, it may cause injury to personnel or damage to equipment.

Tilting left-right

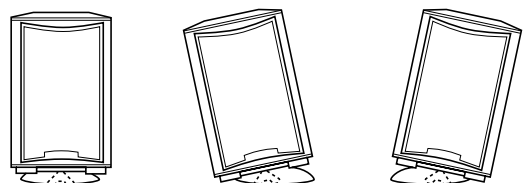

About discs

Playable disc types

Playable and non-playable disc types are as follows:

Playable discs



The DVD Logo is a trademark.

Non-playable discs

- DVD-ROM
- DVD-RAM
- DVD-R
- DVD-RW
- CD-R
- CD-ROM
- PHOTO CD
- CD-RW

- Playing back discs list as “Non-playable discs” above may generate noise and damage speakers.

Notes on DVD VIDEO discs

- DVD players and DVD VIDEO discs have their own Region Code numbers. This unit only can play back DVD discs whose Region Code numbers include “1”.

Examples of playable DVD discs:



- This unit is designed to use the NTSC system. The unit cannot play back the disc recorded on the PAL system.

Disc structure

A DVD disc is comprised of “titles”, while an Audio CD or Video CD is comprised of “tracks”. Each title may be divided into some “chapters”. For example, if a DVD disc contains some movies, each movie, each movie may have its own title number, and each movie may be divided into some chapters. In a DVD karaoke disc, each song usually has its own title number and does not have chapters. In general, each title has independent content, while each chapter in the same title has continuity.

Example: DVD disc

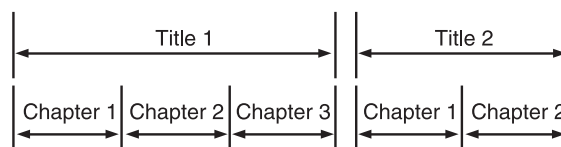

Example: Audio CD/Video CD

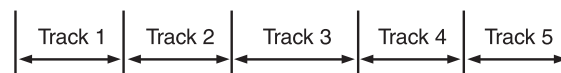

Video CDs with Playback Control function

What is Playback Control function?

The Playback Control function, allows you to enjoy menu-driven operation and high-resolution still images which have a resolution four times greater than moving pictures.

• Menu-driven playback

You can interact with the screen using a menu display to select and play an entry.

• High-resolution still image display

You can display high-quality images four times clearer than moving pictures.

A selection menu is displayed when you start playing a Video CD disc with the Playback Control feature. The selection menu shows a list of numbers for selection. Some discs may show moving pictures or a divided screen.

1. When a list of numbers is displayed, selecting a number shows its contents.
2. When “▶” or “SELECT” is displayed on the television screen, pressing this button jumps to the specific picture.
3. When the selection menu is redisplayed after you have played your selection, selecting a number again replays its contents.

(Some discs may show the menu screen several times.)

When ▶▶ and ◀◀ are shown, pressing “NEXT” or “PREV” can change the selection menu.

4. After playback, press RETURN to go back to the previous screen.

To stop playback, press STOP.

Note:

- When a menu is displayed for a long time (about ten minutes), the screen background automatically fades out to prevent screen burn-in while the setting is suspended.

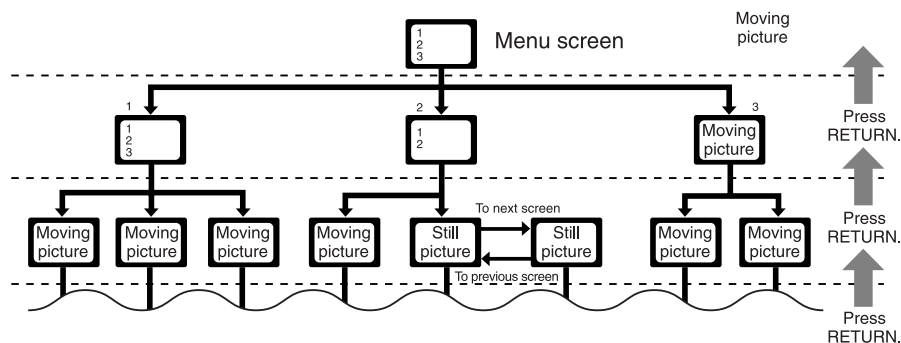

Connections

Connecting the FM and AM antennas

FM antenna connections

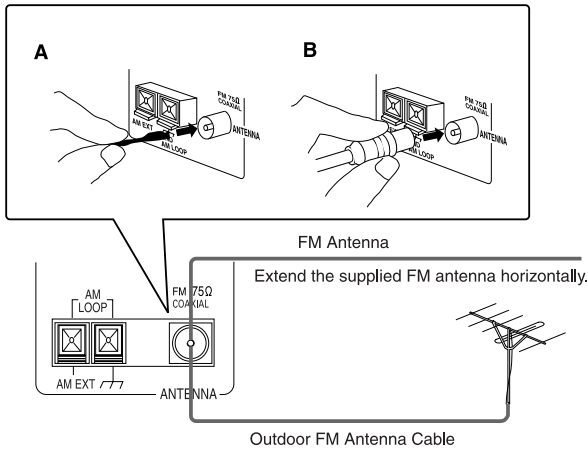

A. Using the supplied FM antenna

The FM antenna provided can be connected to the FM 75Ω COAXIAL terminal as temporary measure.

B. Using the standard type connector (Not supplied)

A standard type connector should be connected to the FM 75Ω COAXIAL terminal.

Note:

- If reception is poor, connect the outdoor antenna. Before attaching the 75 Ω coaxial cable (the kind with a round wire going to an outdoor antenna), disconnect the supplied FM antenna.

AM antenna connections

Turn the loop until you have the best reception.

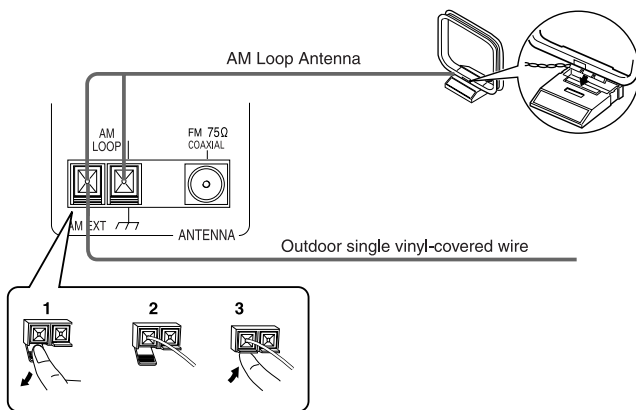

Notes:

- Make sure the antenna conductors do not touch any other terminals, connecting cords and power cord. This could cause poor reception.
- If reception is poor, connect an outdoor single vinyl-covered wire to the AM EXT terminal. (Keep the AM loop antenna connected.)

To connect the powered sub-woofer

Use the supplied system cable to connect the powered sub-woofer (SP-PWA10).

Center unit (XV-THA10)

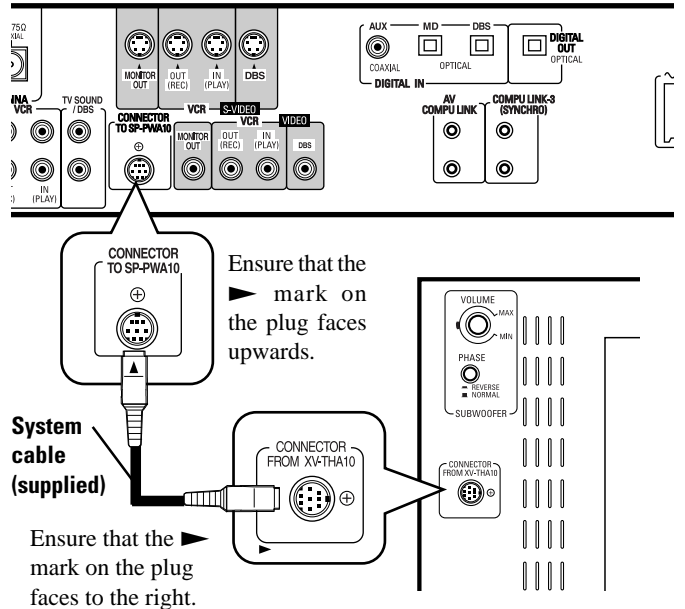

Powered sub woofer (SP-PWA10)

CAUTION:

- Use the system cable provided for attaching the center unit and the sub woofer.

Connecting the TV

Connect the TV to view video images from the center unit.

S-video cable (not supplied)

Connect to the TV if it has an S-video input (for higher image quality). Connect the cables with the ► mark facing down.

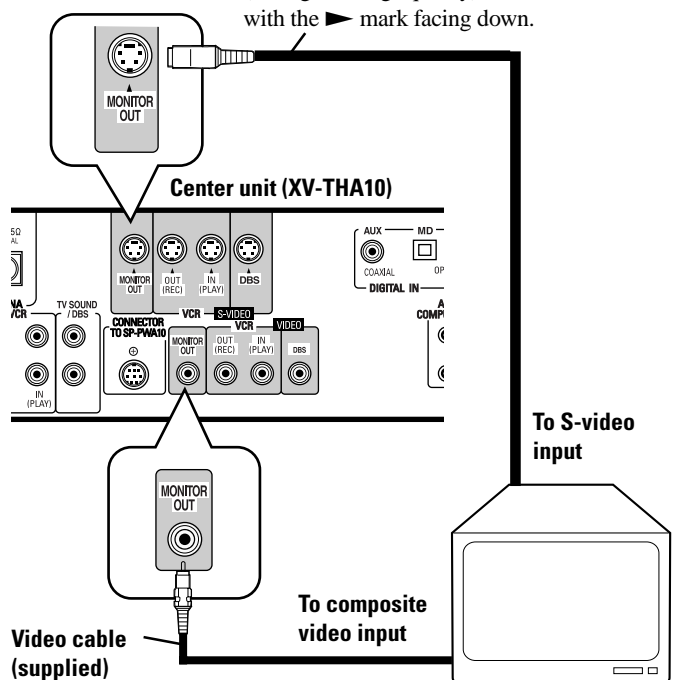

Note:

- When connecting the TV to the TV SOUND/DBS jacks, DO NOT connect the TV'S-video output to these video input terminals.

To connect speakers

Connect the satellite speakers and center speaker to the terminals on the powered sub-woofer using the speaker cords supplied. Labels are attached to the speaker cords to indicate the speaker and terminal to which each is to be connected.

- The four satellite speakers may be used at either front or rear.
- Ensure that the left and right speakers are connected to left and right respectively, and that they are connected with the correct polarity (+ve, -ve). The white speaker cord connects to the + terminal, and the black speaker cord connects to the - terminal.

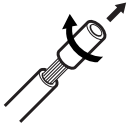

Twist and remove the insulation at the end of each speaker cord.

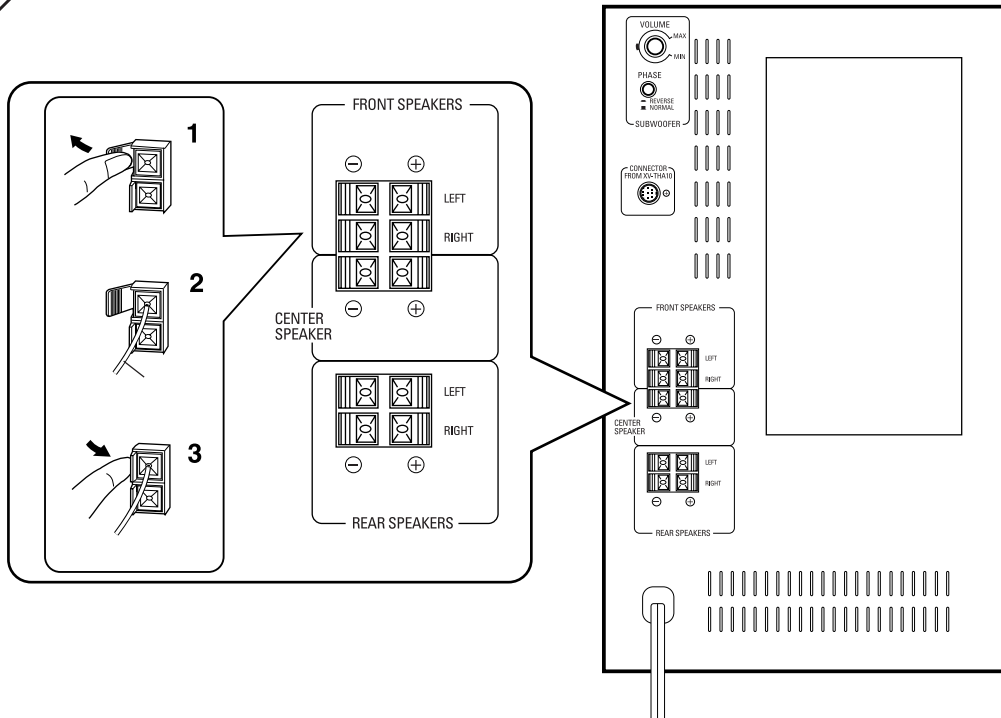

Connecting the front speakers

Connect the right speaker to the FRONT SPEAKERS RIGHT terminal.
Connect the left speaker to the FRONT SPEAKERS LEFT terminal.

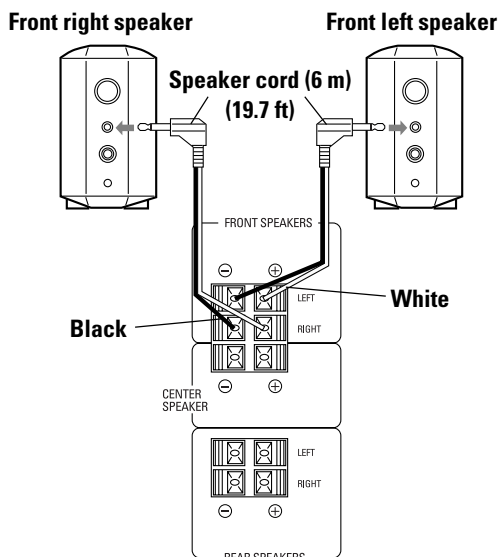

Connecting the rear and center speakers

Connect the right rear speaker to the REAR SPEAKERS RIGHT terminals.
Connect the left rear speaker to the REAR SPEAKERS LEFT terminals.
Connect the center speaker to the CENTER SPEAKER terminals.

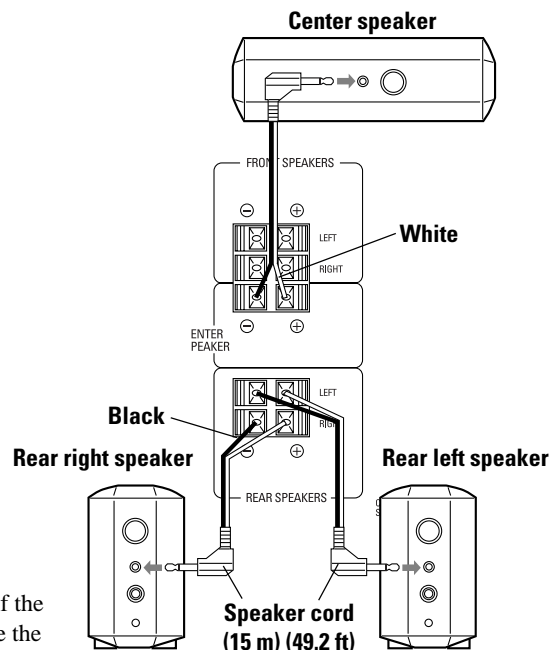

Note:

- Mixing up the polarity of the speaker cords can reduce the stereo effect and sound quality.

Connecting Audio/Video Components

You can connect the following audio/video components to this system.

Refer also to the manuals supplied with your components.

Audio Components: Cassette deck or MD recorder*

Video Components: TV or DBS tuner*
VCRs

* You can connect these components using the methods described in "Analog connections" (see below) or in "Digital connections" (see page 9).

Analog connections

Analog component connections

Use the cable with RCA pin plugs (not supplied).

Connect the white plug to the audio left jack, and the red plug to the audio right jack.

CAUTION:

If you connect a sound-enhancing device such as a graphic equalizer between the source components and the center unit, the sound output through this system may be distorted.

Cassette deck or MD recorder

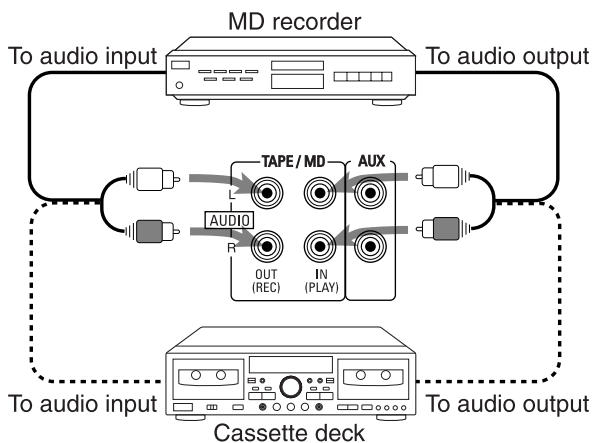

Notes:

- When the DSP mode is ON, the VCR OUT (REC) jack and the TAPE/MD OUT (REC) jack will output surround sound to the front speakers only. When recording, turn the DSP mode OFF (see page 21).
- You can connect either a cassette deck or a MD recorder to the TAPE/MD jacks. When connecting a MD recorder to the TAPE/MD jacks, change the source name, which will be shown on the display when selected as the source, to "MD". See page 17 for details.

If your audio components have a COMPU LINK-3 terminal

- See also page 54 for detailed information about the connection and the COMPU LINK-3 remote control system.

Video component connections

Use the cable with RCA pin plugs (not supplied).

Connect the white plug to the audio left jack, the red plug to the audio right jack, and the yellow plug to the composite video jack.

If your video components have S-video (Y/C-separation) terminals, connect them using S-video cable (not supplied).

Connecting these video components through the S-video input/output terminal will give you better picture playback (or recording) quality.

IMPORTANT

This system is equipped with both the composite video and S-video input/output terminals for connecting video components.

You do not have to connect both the composite video and S-video terminals.

However, remember that the video signals from the composite video input terminals are output only through the composite video out terminals, while the ones from the S-video input terminals are output only through the S-video output terminals.

Therefore, if a recording video component and a playing video component are connected to the center unit through the different video terminals, you cannot record the picture from the playing component on the recording component. In addition, if the TV and a playing video component are connected to the center unit through the different video terminals, you cannot view the playback picture from the playing component on the TV.

VCR

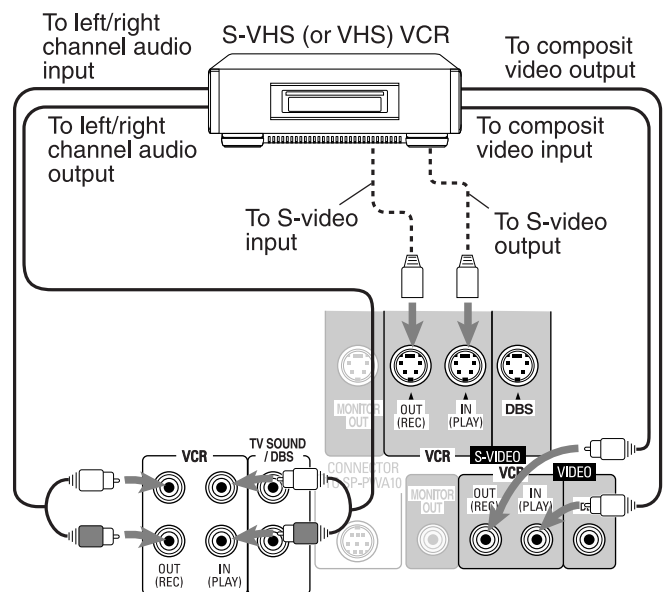

TV audio or DBS tuner

TV sound

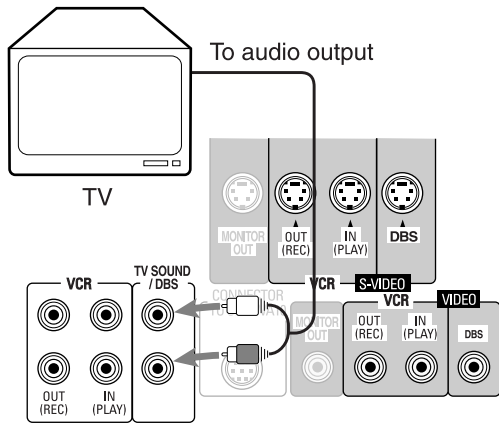

DBS tuner

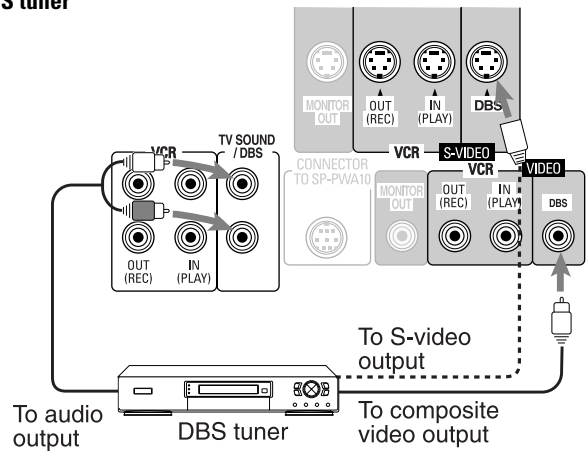

Note:

- When connecting the DBS tuner to the TV SOUND/DBS jacks, change the source name, which will be shown on the display when selected as the source, to “DBS”. See page 17 for details.

Digital connections

The center unit has three digital input terminals (one digital coaxial terminal and two digital optical terminals) and one digital output terminal (a single digital optical terminal).

- The DVD and audio signals from the center unit, and the digital signals input from the digital input terminals, are output from the digital output terminal.

IMPORTANT

- **When connecting the DBS tuner using the digital terminal, you also need to connect it to the video jack (either composite video terminal or S-video terminal) on the rear. Without connecting it to the video jack, you can view no playback picture.**
- **After connecting the components using the DIGITAL IN terminal, set the following correctly if necessary.**
 - **Select the digital input mode correctly. For details, see “Selecting the analog or digital input mode” on page 18.**

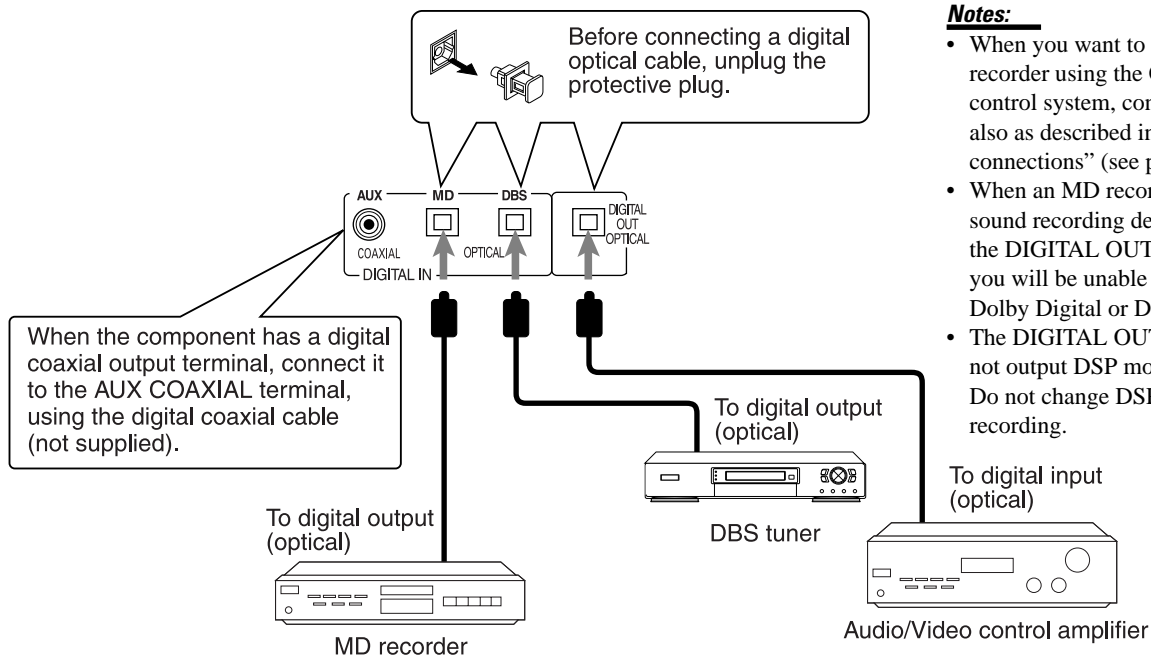

Notes:

- When you want to operate the MD recorder using the COMPU LINK remote control system, connect the MD recorder also as described in “Analog connections” (see pages 8).
- When an MD record or other digital sound recording device is connected to the DIGITAL OUT OPTICAL terminal, you will be unable to record signals in Dolby Digital or DTS Digital Sound.
- The DIGITAL OUT OPTICAL jack does not output DSP mode sound effects. Do not change DSP mode during digital recording.

Connecting the power cord

Before plugging the center unit and powered sub-woofer into an AC outlets, make sure that all connections have been made.

Plug the power cord into an AC outlet.

The red STANDBY lamp on the center unit lights when the power cord is plugged in.

Keep the power cord away from the connecting cables and the antenna cable. The power cord may cause noise or screen interference. We recommend that you use a coaxial cable to connect the FM outdoor antenna, since it is well-shielded against interference.

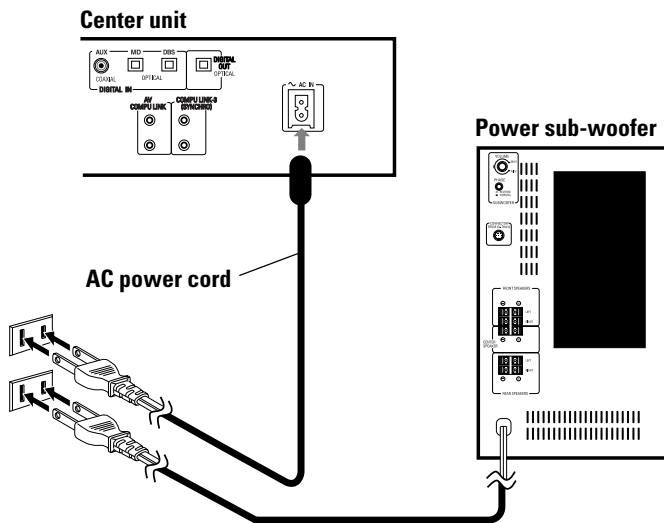

CAUTIONS:

- Do not touch the power cord with wet hands.
- Do not pull on the power cord to unplug the cord. When unplugging the cord, always grasp the plug so as not to damage the cord.

Notes:

- The preset settings such as preset channel and sound adjustment may be erased in a few days in the following cases:
 - When you unplug the power cord.
 - When a power failure occurs.
- The speakers will not produce any sound if the powered sub-woofer power cord is removed from the AC outlet while the center unit is turned on. In this case power will not come on even when the powered sub-woofer power cord is plugged in the AC outlet. Press POWER on the center unit, or AUDIO POWER on the remote control to turn power on. This will turn the powered sub-woofer on and sound will be emitted from the speakers.

Putting batteries in the remote control

Before using the remote control, put two supplied batteries first. When using the remote control, aim the remote control directly at the remote sensor on the center unit.

1 2 3

Primary remote control

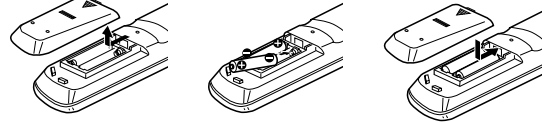

Secondary remote control

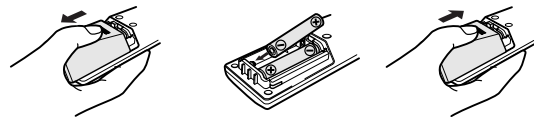

1. On the back of the remote control, remove the battery cover.

2. Insert batteries. Make sure to match the polarity: (+) to (-).

3. Replace the cover.

- If the range or effectiveness of the remote control decreases, replace the batteries. Use two R6P (SUM-3)/AA (15F) type dry-cell batteries.

CAUTIONS:

Follow these precautions to avoid leaking or cracking cells:

- Place batteries in the remote control so they match the polarity: (+) to (-).
- Use the correct type of batteries. Batteries that look similar may differ in voltage.
- Always replace both batteries at the same time.
- Do not expose batteries to heat or flame.

Light up the primary remote control buttons

The buttons on the primary remote control may be lit for a few seconds for use in the dark.

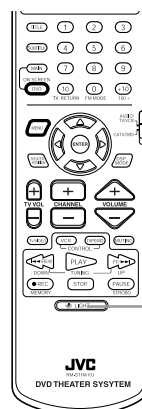

Press LIGHT to illuminate the buttons in red for a few seconds.

Parts Identification

Become familiar with the buttons and controls on the unit before use. Refer to the pages in parentheses for details.

Center unit

Front panel

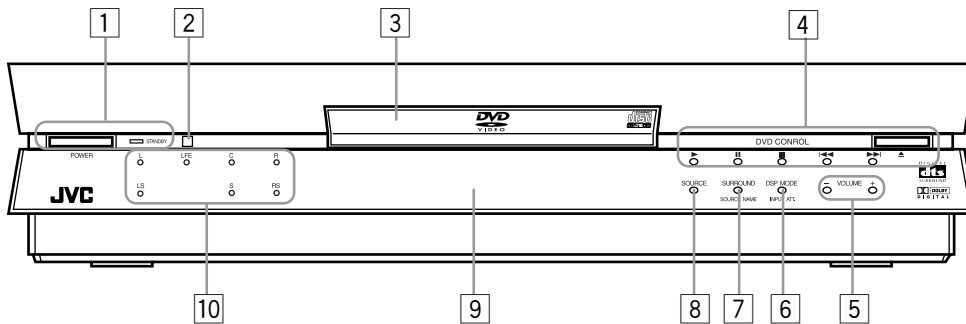

- 1 POWER button and STANDBY lamp (16)
- 2 Remote sensor (10)
- 3 Disc tray (22)
- 4 DVD CONTROL buttons (22~24)
- 5 VOLUME +/- button (16)
- 6 DSP MODE /INPUT ATT. (19, 20, 21)
- 7 SURROUND/SOURCE NAME (17, 21)
- 8 SOURCE (17)
- 9 Display window
- 10 Audio channel lamp (19)

Display window

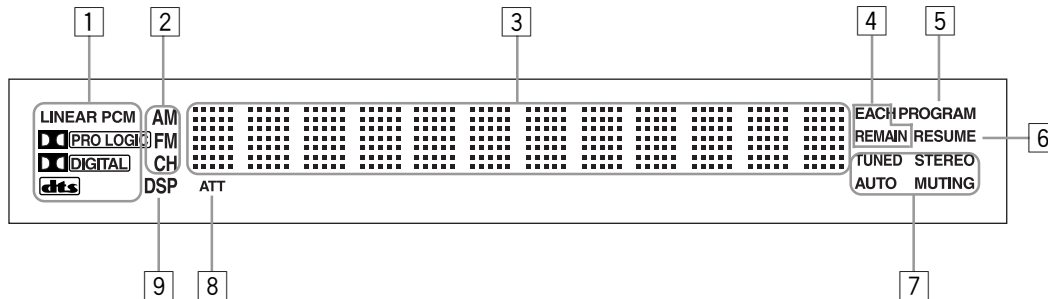

- 1 Record mode indicator (18)
- 2 Radio indicator (36)
- 3 Multi-information window Display time and status information.
- 4 Time selection indicator (34)
- 5 PROGRAM indicator (34)
- 6 RESUME indicator (24)
- 7 Radio reception mode indicator (37)
- 8 ATT. indicator (19)
- 9 DSP indicator (20)

Powered sub-woofer

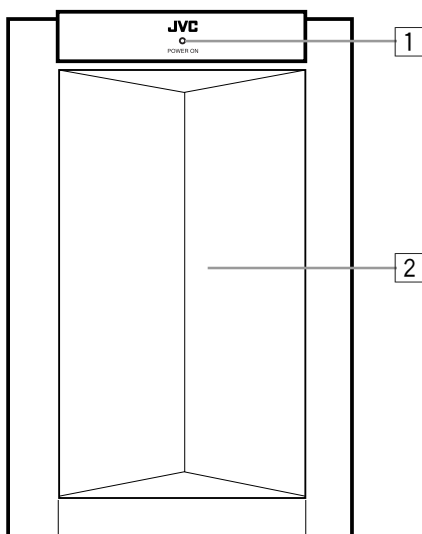

- 1 POWER ON lamp (16)
- 2 Speaker

Remote controls

Primary remote control

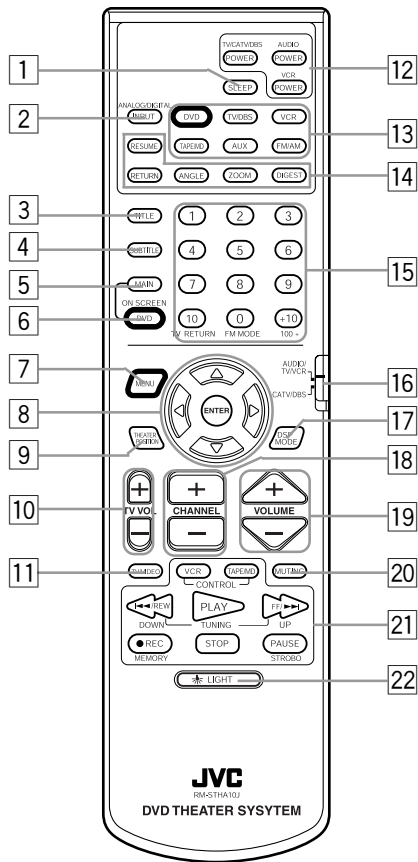

- 1 SLEEP button (20)
- 2 ANALOG/DIGITAL INPUT button (18)
- 3 TITLE button (24)
- 4 SUBTITLE button (29)
- 5 MAIN ON SCREEN button (39)
- 6 DVD ON SCREEN button (26, 46)
- 7 MENU button (24)
- 8 Cursor and ENTER buttons
- 9 THEATER POSITION button (31)
- 10 TV VOL +, - button (56)
- 11 TV/VIDEO button (56)
- 12 POWER buttons
AUDIO POWER button (16)
TV/CATV/DBS POWER button (56)
VCR POWER button (56)
- 13 Source selecting buttons (17)
DVD, TV/DBS, VCR, TAPE/MD, AUX, FM/AM
- 14 DVD operating buttons
RESUME (24)
RETURN (25)
ANGLE (30)
ZOOM (29)
DIGEST (27)
- 15 Number buttons
- 16 Remote control mode selector (55, 56)
- 17 DSP MODE button (21)
- 18 CHANNEL +/- button (56)
- 19 VOLUME +/- button (16)
- 20 MUTING button (17)
- 21 Operating buttons
- 22 LIGHT button (10)

Secondary remote control

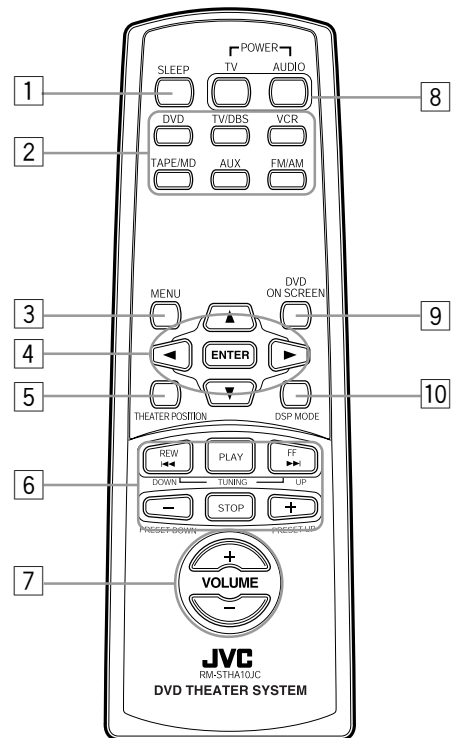

- 1 SLEEP button (20)
- 2 Source selecting buttons (17)
- 3 MENU button (24)
- 4 Cursor and ENTER buttons
- 5 THEATER POSITION button (31)
- 6 Operating buttons
- 7 VOLUME +/- button (16)
- 8 POWER buttons
AUDIO button (16)
TV button (56)
- 9 DVD ON SCREEN button (26, 46)
- 10 DSP MODE button (21)

Principles of operation

The system may be operated via the remote control or the buttons on the center unit, or via the menu on the screen.

Operation with the remote control

Select the appropriate mode for the remote control when using the primary or secondary remote control is used for operation. The remote control mode is selected by pressing the source selecting buttons.

Press DVD : The number buttons and operating buttons operate in the DVD mode, enabling operation of the DVD, audio CD, and video CD.

Press FM/AM : The number buttons and operating buttons operate in the radio mode.

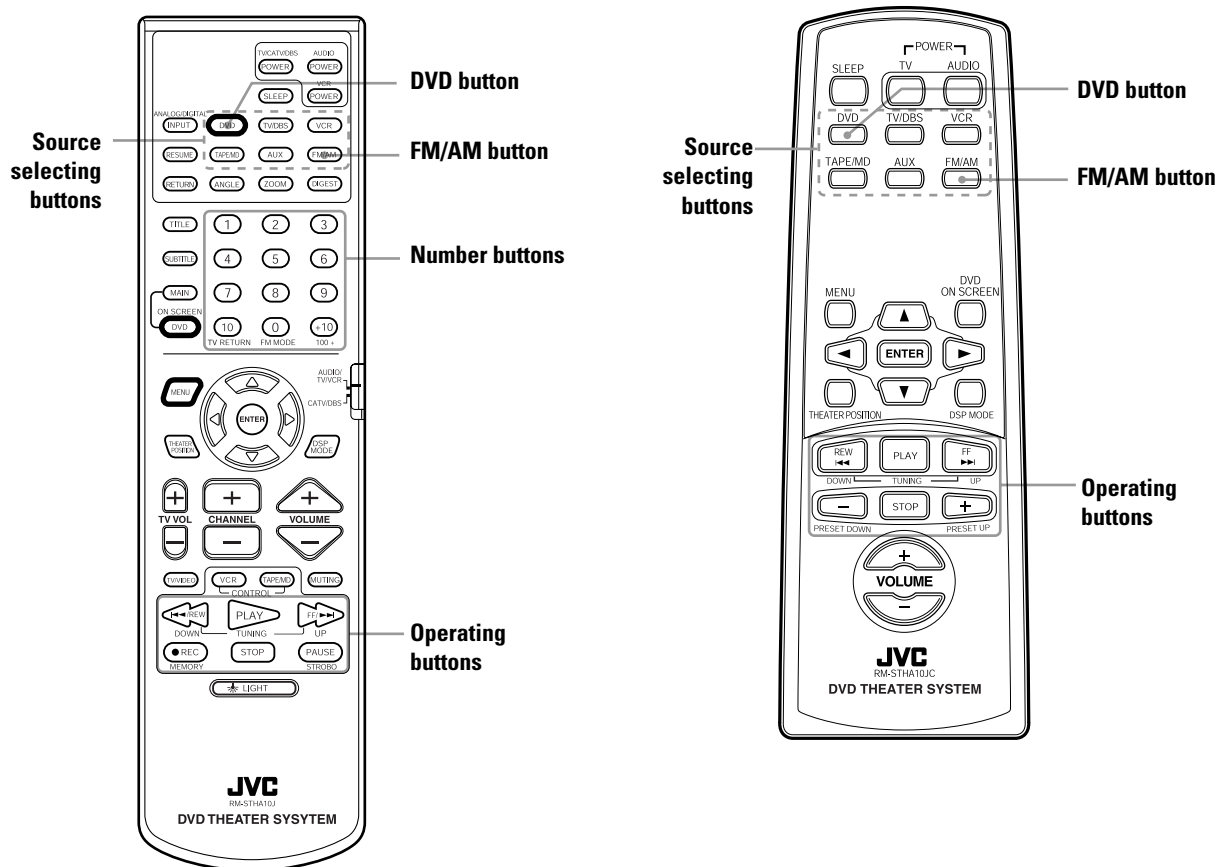

Note:

- Pressing the source selecting buttons on the remote control also changes the remote control mode. When using the remote control, always press the source selecting buttons on the equipment to suit the appropriate remote control mode.

To operate via the on-screen menu

When using the on-screen menu, first display it and then use the primary or secondary remote control unit cursor buttons (◀/▶/▲/▼), the number buttons, and the ENTER button.

Displaying the on-screen menu

The method and conditions for display differ with the on-screen menu. The individual functions are described below.

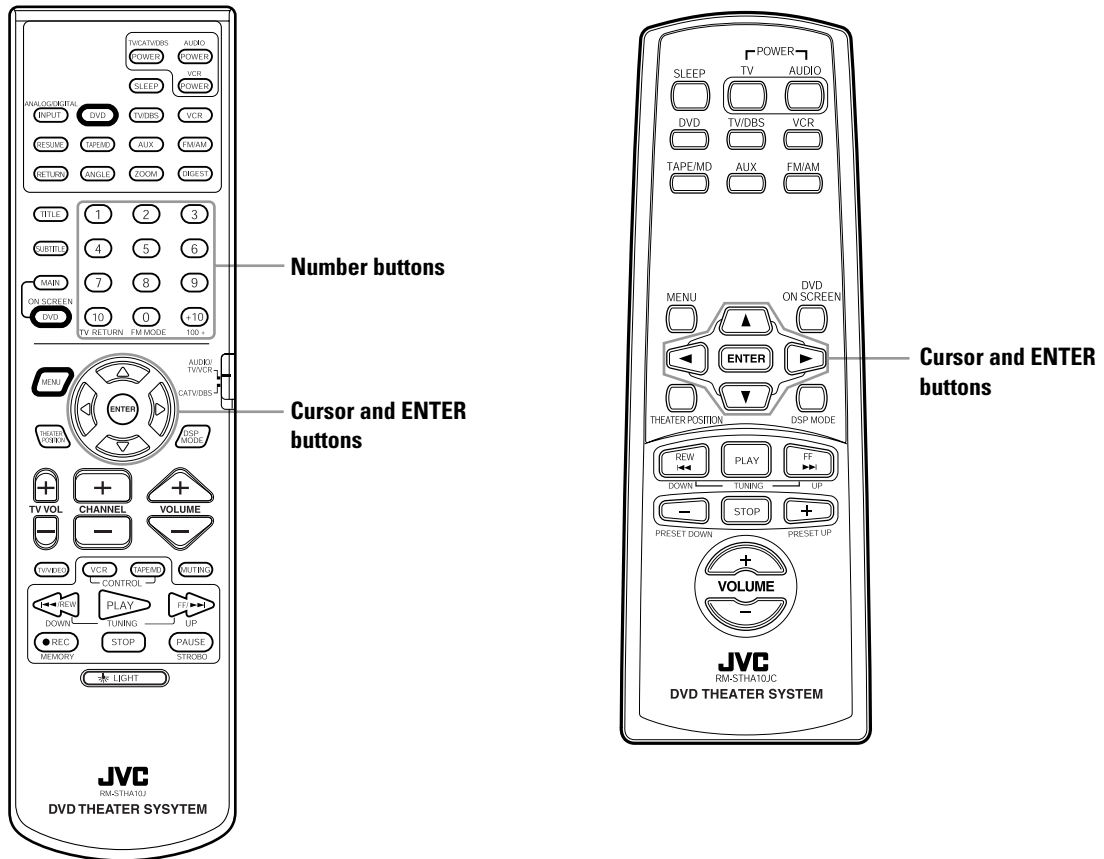

On-screen menu components

Referred to as a "tag".

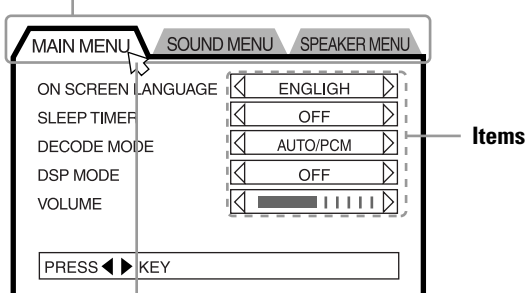

This arrow is referred to as a "pointer".

Basic operation with the on-screen menu

1. **Move the pointer to the desired item using the remote control buttons.**
 - Use the ◀/▶ cursor to select a tag.
 - Use the ▲/▼ cursor to select an item.
2. **Use the items.**
 - Use the ◀/▶ cursor to change the details of a selected item.
 - Press ENTER to use the selected item.
 - Follow the method of use explained in the message field.
 - Use the number buttons to enter numerals.

See each function description for details of use.

On-screen menus

This system supports the following on-screen menus.

Opening screens

(No disc inserted)

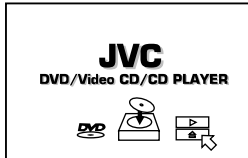

for DVD



for Video CD



for Audio CD

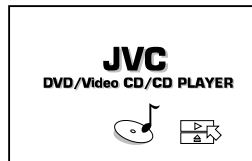

On-screen menus for using and setting up the AV amp function

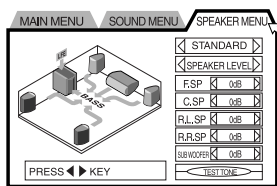
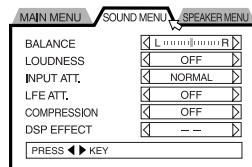
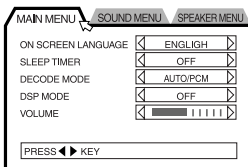

On-screen menus for setting up the DVD

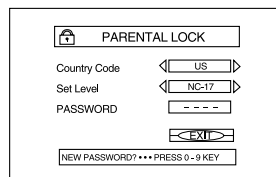
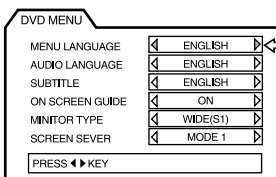

On-screen menus for using the disc

DVD CONTROL display

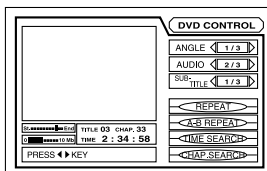

VCD CONTROL display

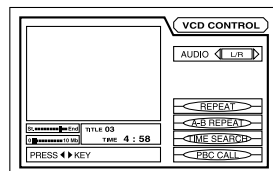

CD CONTROL display

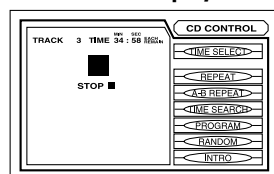

On-screen menus for using discs

The disc status and items are displayed as follows on the on-screen menus for using the disc.

DVD CONTROL display

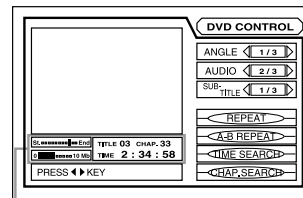

Current relative position of the title (St: start, End: end) Current title number Current chapter number

Transmission rate Elapsed time from the beginning of the current title

VCD CONTROL display

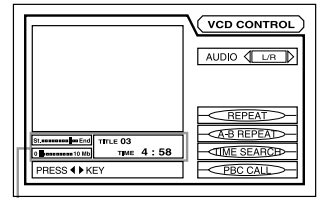

Current relative position of the track (St: start, End: end) Current track number

Transmission rate Elapsed time from the beginning of the current track

CD CONTROL display

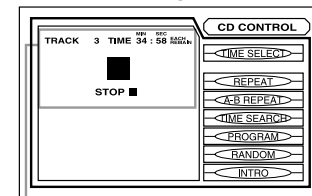

Current track number Elapsed time from the beginning of the current track

TRACK 3 TIME 34 : 58

Disc status

Preventing screen burn-out with the screen saver [SCREEN SAVER]

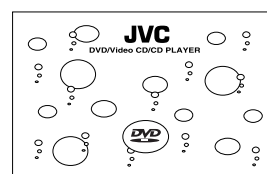

A television monitor screen may be burned out if a static picture is displayed for a long time. To prevent this, the unit automatically activates the screen saver function if a static picture, such as an on-screen display or menu, is displayed for over 5 minutes.

- Pressing any button on the unit or the remote control unit will release the screen saver function and return to the previous display.
- You can select one of several screen saver modes available (see page 48).

Basic operations

The basic operations for this system are as follows.

IMPORTANT

Check that remote control mode selector is set to the current position when using the primary remote control:

Set to "AUDIO/TV/VCR" to operate an audio system, TV, or VCR.

Set to "CATV/DBS" to operate a CATV converter or DBS tuner.

The system will not operate normally while in CATV/DBS mode.

To turn the system power supply ON and OFF (standby)

From the remote controls:

Primary remote control

Secondary remote control

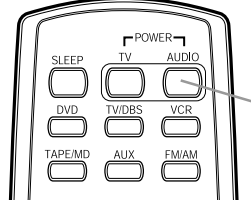
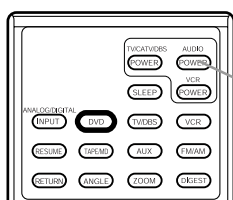

AUDIO POWER

AUDIO POWER

Press AUDIO POWER to turn power ON.

The STANDBY lamp goes off, and the current source name (or station frequency) appears on the display window

The center unit POWER button and ▲ button will light up blue.

Press AUDIO POWER again to turn power OFF (standby).

The STANDBY lamp is lit.

On the front panel:

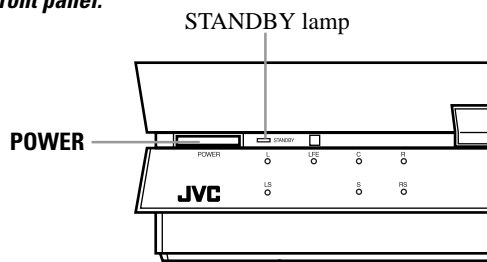

Press POWER to turn power ON.

The STANDBY lamp goes off, and the current source name (or station frequency) appears on the display window.

The center unit POWER button and ▲ button will light up blue.

Press POWER again to turn power OFF (standby).

The STANDBY lamp is lit.

Notes:

- The powered sub-woofer power supply is linked to the center unit. The green POWER ON lamp on the powered sub-woofer lights when power is turned on, and goes off when power is turned off.
- A small amount of power is consumed in the standby mode. Remove both AC power cords from the AC outlets to turn the center unit and powered sub-woofer off completely.

To turn TV power ON and OFF

JVC TVs may be used as is with the primary and secondary remote controls. TVs from other manufacturers require changes to the transmittable signals before they can be used with the primary and secondary remote controls. See page 57 for details of changing the transmittable signals.

From the remote controls:

Primary remote control

Secondary remote control

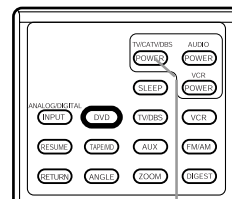

TV/CATV/DBS POWER

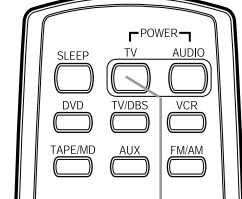

TV POWER

Press TV/CATV/DBS POWER (or TV POWER) to turn power ON.

Press TV/CATV/DBS POWER (or TV POWER) again to turn power OFF.

Adjusting volume

The volume level can be adjusted within the range of "0" (minimum) to "80" (maximum).

Common:

Primary remote control

Secondary remote control

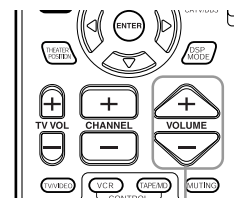

VOLUME +/-

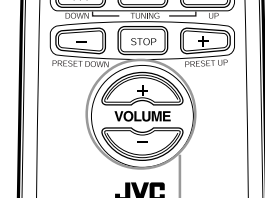

VOLUME +/-

On the front panel

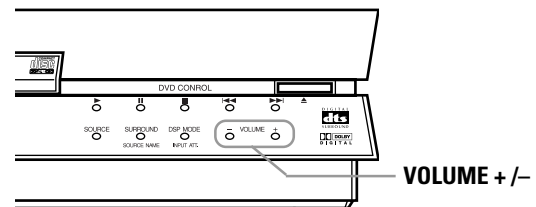

Press VOLUME + or -.

Press VOLUME + to increase volume.

Press VOLUME - to decrease volume.

CAUTION:

Always set the volume to the minimum before starting any source. If the volume is set at its high level, the sudden blast of sound energy can permanently damage your hearing and/or ruin your speakers.

Muting the sound

Primary remote control only:

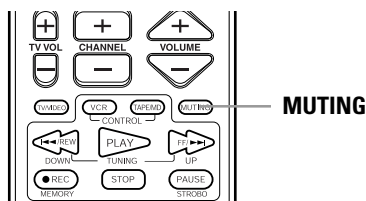

Press **MUTING** to mute the sound through all speakers connected.

“MUTING” appears on the display window and volume turns off.

To restore the sound, press **MUTING** again so that “OFF” appears on the display.

- Pressing **VOLUME +/-** also restores the sound.

Selecting the source to play

Selected source name appears

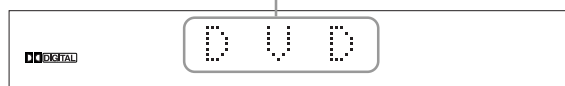

From the remote controls:

Primary remote control

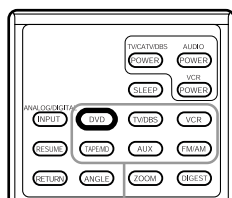

Source selecting buttons

Secondary remote control

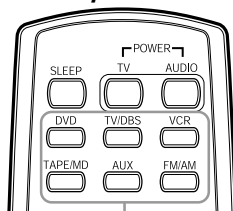

Source selecting buttons

Press one of the source selecting buttons.

- | | |
|-----------------|--|
| DVD* | Select the DVD player. |
| TV/DBS | Select TV sounds or DBS tuner. |
| VCR | Select the video component connected to the VCR jacks. |
| TAPE/MD* | Select the cassette deck (or the MD recorder). |
| AUX* | Select a component connected to the AUX jack. |
| FM/AM* | Select an FM or AM broadcast. |
| | Each time you press the button, the band alternates between FM and AM. |

Notes:

- When connecting an MD recorder (to TAPE/MD jacks), and a DBS tuner (to the TV SOUND/DBS jacks), change the source name shown on the display window. For details, “Changing the source name”.
- When you press one of the source selecting buttons on the remote control marked above with an asterisk (*), the system automatically turns on.

On the front panel:

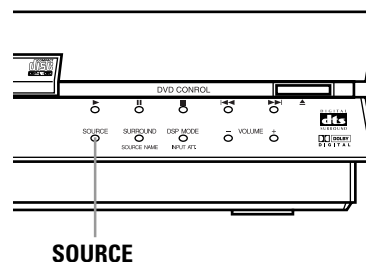

Press **SOURCE** until the source name you want appears on the display.

The source changes as shown below each time the button is pressed.

- DVD → TAPE (or MD) → VCR → AM → FM →
TV SOUND (or DBS) → AUX → (back to the beginning)

Changing the source name

When you have connected an MD recorder to the TAPE/MD jacks or the DBS tuner to the TV SOUND/DBS jacks on the rear panel, change the source name shown on the display window when you select the MD recorder or DBS tuner as the source.

On the front panel:

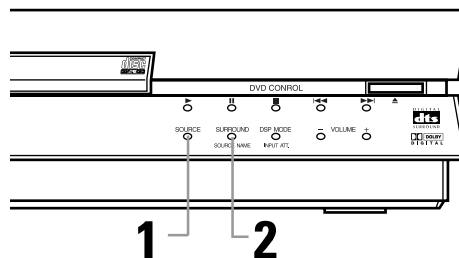

1. When changing the source name from “TAPE” to “MD”:
Press **SOURCE** until “TAPE” appears.
When changing the source name from “TV SOUND” to “DBS”:
Press **SOURCE** until “TV SOUND” appears.
2. Press and hold **SOURCE NAME** until “ASSGN. MD” or “ASSGN. DBS” appears on the display window.

To change the source name to “TAPE” or “TV SOUND”, repeat the same procedure above — in step 1, select “MD” or “DBS” then press and hold **SOURCE NAME**.

Note:

- Without changing the source name, you can still use the connected components, there may be some inconvenience.
- “TAPE” or “TV SOUND” will appear on the display window when you select the MD recorder or DBS tuner.
 - You cannot use the digital input (see page 9) for the MD recorder and the DBS tuner.
 - You cannot use the COMPU LINK remote control system (see page 54) operate the MD recorder.

Selecting the analog or digital input mode

When you have connected some components such as MD recorder, the DBS tuner and so on, using digital terminals (see page 9), you need to change the input mode for these components to the digital input. You can choose digital sound from the following sources: “MD”, “DBS”, “AUX”.

Primary remote control only:

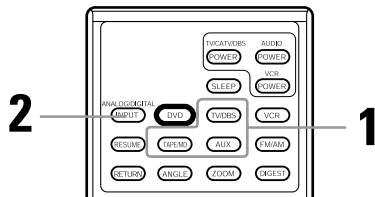

1. Press the source selecting button (TAPE/MD, AUX, or TV/DBS) for which you want to change the input mode from analog input to digital input.

Example: Selecting MD recorder as the source for digital audio.

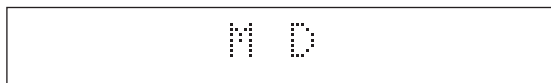

2. Press ANALOG/DIGITAL INPUT.

The display changes as shown below each time the button is pressed.

→ AUTO/PCM → DOLBY DGTL (DOLBY DIGITAL) → DTS → ANALOG → (back to the beginning)

3. Press ANALOG/DIGITAL INPUT to select [AUTO/PCM].



↓ After approximately 3 seconds

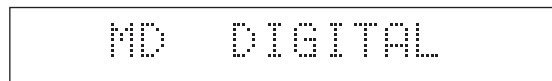

- The source name changes from “MD” to “MD DIGITAL”.

When other than [AUTO/PCM] is selected

When “DOLBY DGTL” or “DTS” is selected the source name changes to digital (“MD” → “MD DIGITAL”) and audio is not played.

The decode mode indicator “DOLBY DIGITAL” or “DTS” in the display window flashes to indicate that the correct mode has not been selected.

Example: Selecting “DOLBY DGTL” when listening to MD with digital audio.



Flashes

To return to analog audio

1. Select a digital source to return to analog audio.
Select from “MD DIGITAL”, “AUX DIGITAL”, or “DBS DIGITAL”.
2. Press ANALOG/DIGITAL INPUT to select [ANALOG].
Analog audio is selected and the source name also returns to analog.

Note:

- When selecting a digital source, press ANALOG/DIGITAL INPUT once to display the currently selected mode.

Changing the decode mode

Primary remote control only:

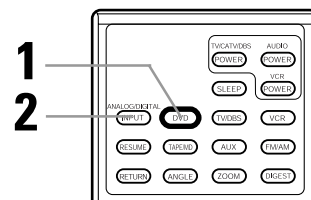

1. Press DVD to select DVD as the source.

2. Press ANALOG/DIGITAL INPUT to select the decode mode.

The display changes as shown below each time the button is pressed.

→ AUTO/PCM → DOLBY DGTL (DOLBY DIGITAL) → DTS → (back to the beginning)

AUTO/PCM	Optimized for all discs playable on this system. (Default)
DOLBY DGTL	Select this mode when playing a disc recorded in Dolby Digital Surround.
DTS	Select this mode when playing a DVD disc recorded in DTS Surround. The DTS decoder will be selected as the internal decoder.

When to try changing the decode mode

When the decode mode is set to the default AUTO/PCM setting and a DVD recorded in Dolby Digital Surround or DTS Digital Surround is played, the internal decoder will be automatically selected before audio playback begins. Depending on the disc, this may result in a brief loss of audio after playback starts. This is due to lost audio signals that were inputted during internal decoder selection.

In these instances, lost audio can be prevented by manually selecting the decode mode appropriate for the disc you wish to play.

However, please note that when the decode mode is set to other than AUTO/PCM, you will be unable to playback audio from discs recorded in a mode other than the set mode.

After changing the decode mode and playing back a disc, return the decode mode to “AUTO/PCM”.

Changing the playback source will automatically set the decode mode to “AUTO/PCM”.

When a decode mode which differs from the type of disc being played is selected

Insert a DVD disc in the center unit to display the type of audio being played in the Decode mode indicator in the display window. Audio cannot be played if a decode mode which differs from the displayed mode is selected.

The selected decode mode flashes to indicate that the selected decode mode does not allow audio playback.

Example: When DTS is selected as the decode mode for Dolby digital audio.

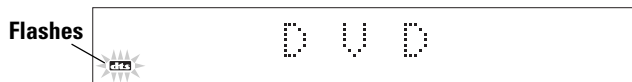

Adjusting the Input Signal Level

When using the DSP mode effect during playback from an analog device, the sound will occasionally be distorted due to a overly-strong input signal. In these instances, it is possible to adjust the level of the input signal. Only input signals from analog devices (TV SOUND, VCR, TAPE, AUX, FM, AM, MD, DBS) may be adjusted in this way.

On the front panel only:

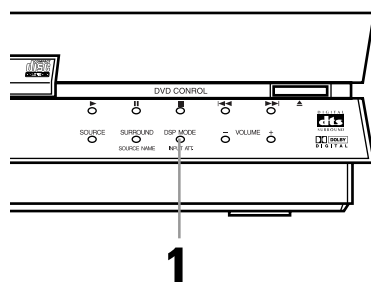

1 Press and hold INPUT ATT. (DSP MODE).

Release the button when the display window shows "INPUT ATT ON," or "INPUT NORMAL."

Pressing and holding the INPUT ATT. Button further cycles through the following modes:

INPUT NORMAL: Playback source without adjusting the input signal level. This is the default setting.



INPUT ATT ON: Lower the input level and playback source.

The ATT mark will light up.

To change the input signal level, press and hold INPUT ATT. until "INPUT NORMAL" or "INPUT ATT ON" is displayed.

Note:

- When in "INPUT ATT ON" mode, ATT will light up in the display window. However, when the playback source is digital (DVD, etc.) it will go off. Lighting up will resume if playback is switched to an analog device.
- Even while in "INPUT ATT ON" mode, if the DSP mode is turned off ("DSP OFF"), playback will continue without any reduction of the input signal.

Sub-woofer volume control and phase setting

Use the VOLUME knob and PHASE button at the rear of the powered sub-woofer.

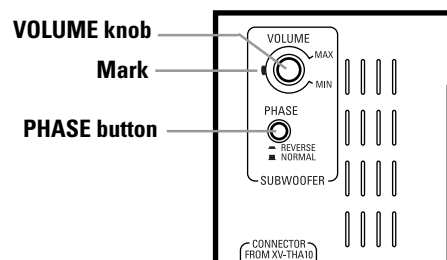

Volume control

Turn the VOLUME knob.

Adjust to a volume appropriate for balance with the other speaker(s). The mark indicates the volume position in normal use.

- Adjust when the volume from the sub-woofer is too high or too low in relation to the volume from the front speaker.

Phase setting

Play sound through the sub-woofer and adjust the PHASE button to a position (◡ REVERSE or ◼ NORMAL) at which the lowest frequency is heard best.

Note:

- Phase is closely related to the distance from the listening position to the front speaker and sub-woofer. While listening, adjust until the lowest frequency is heard best.

Audio channel display lamp

Uses lamps to display the audio channel configuration for the disc currently playing.

- The audio channel display lamp is not an indicator of which speakers are producing sound.

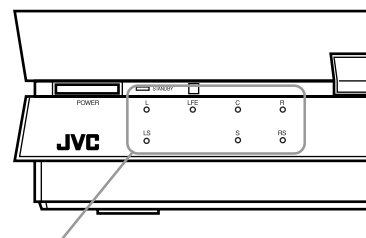

The lamps refer to the speaker channel as follows.

- L:** Left front speaker channel
- R:** Right front speaker channel
- C:** Center speaker channel
- RS:** Right surround speaker channel
- LS:** Left surround speaker channel
- S:** Rear speaker channel (monaural)
- LFE:** Sub-woofer channel

The lamp display indicates the type of disc (DVD or CD) currently playing as follows.

With Dolby digital 5.1 ch or DTS digital 5.1 ch surround

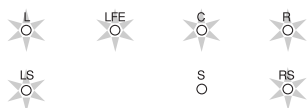

With Dolby digital (Lt/Rt *)

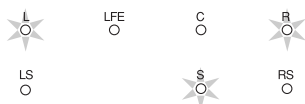

With stereo sound (eg Audio CD)



* Lt/Rt refers to the downmix output when connected to a device that uses Dolby Pro Logic.

Using the Sleep Timer

Using the Sleep Timer, you can fall asleep to music and know the system will turn off by itself rather than play all night.

From the remote controls:

Primary remote control

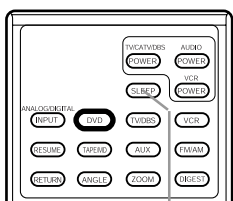

SLEEP

Secondary remote control

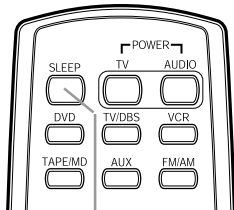

SLEEP

Press SLEEP repeatedly.

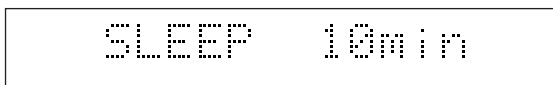

The shut-off time changes as follows (in minutes):

- 10→20→30→60→90→120→150→OFF (Canceled)→ (back to the beginning)

When the shut-off time comes

The system turns off automatically.

To check or change the time remaining until the shut-off time

Press SLEEP once.

The remaining time until the shut-off time appears in minutes.

- To change the shut-off time, press SLEEP repeatedly.

To cancel the Sleep Timer

Press SLEEP repeatedly until "SLEEP OFF" appears on the display window.

- Turning off the power also cancels the Sleep Timer.

Using the DSP Modes

The built-in Surround Processor provides two types of the DSP (Digital Signal Processor) mode — Surround mode and DAP (Digital Acoustic Processor) mode.

Surround modes

With this system, you can use two types of the Surround mode.

Dolby Surround (Dolby Digital and Dolby Pro Logic)*

Used to watch the soundtracks of software encoded with Dolby Digital (bearing the mark ) or with Dolby Surround (bearing the mark .

Dolby Digital and Dolby Pro Logic can be selected automatically according to software played back.

DTS Digital Surround**

DTS Digital Surround is a discrete 5.1 channel digital audio format available on CD and DVD software.

To watch the soundtracks of video software bearing the mark , the system can provide you with DTS Digital Surround decoder.

DTS Digital Surround is automatically selected according to software played back.

Note:

- Change the decode mode from "AUTO/PCM" to "DTS" before playing an audio CD recorded with DTS Digital Surround..
- * Manufactured under license from Dolby Laboratories. "Dolby", "Pro Logic", and the double-D symbol are trademarks of Dolby Laboratories. Confidential Unpublished Works. c1992-1998 Dolby Laboratories, Inc. All rights reserved.
- ** Manufactured under license from Digital Theater Systems, Inc. US Pat. No. 5,451,942 and other world-wide patents issues and pending. "DTS" and "DTS Digital Surround" are trademarks of Digital Theater Systems, Inc. c1996 Digital Theater Systems, Inc. All rights reserved.

DAP modes

The sound heard in a concert hall or club consists of direct sound and indirect sound — early reflections and reflections from behind. Direct sounds reach the listener directly without any reflection. On the other hand, indirect sounds are delayed by the distances of the ceiling and walls. These direct sounds and indirect sounds are the most important elements of the acoustic surround effects. The DAP mode can create these important elements, and gives you a real "being there" feeling.

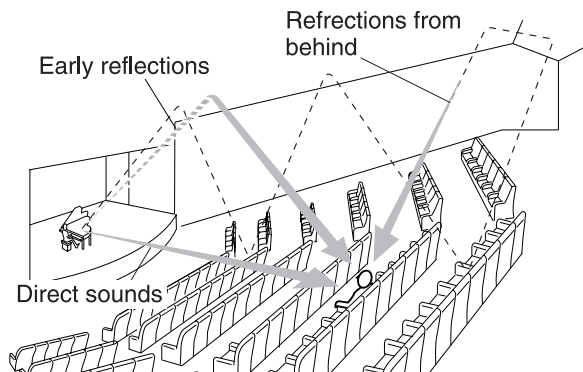

- THEATER:** Gives the feeling of a large theater.
LIVE CLUB: Gives the feeling of a live music club with a low ceiling.
DANCE CLUB: Gives a throbbing bass beat.
HALL: Gives clear vocal and the feeling of a concert hall.
PAVILION: Give the spacious feeling of a pavilion with a high ceiling.

Notes:

- The DSP modes have no effect on monaural sources.
- The DOLBY DIGITAL indicator lights up when the signals encoded with Dolby Digital come into the system.
- The PRO LOGIC indicator lights up when the signals encoded with Dolby Pro Logic decoder built in this system is activated.
- The dts indicator lights up when the signals encoded with DTS Digital Surround come into the system.
- The effects may be adjusted with “SOUND MENU settings” when the DAP mode is selected (see page 41).

IMPORTANT

Before recording a digital source, turn off the DSP mode.

To select the DSP mode

From the remote controls:

Primary remote control

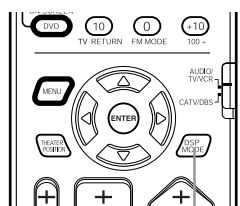

DSP MODE

Secondary remote control

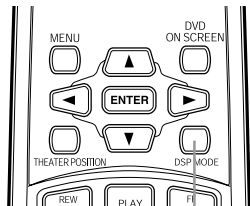

DSP MODE

Press DSP MODE.

The currently selected DSP mode appears on the display when the button is pressed, and changes as follows each time the button is pressed subsequently.

→ SURROUND ON → THEATER → LIVE CLUB → DANCE CLUB → HALL → PAVILION → DSP OFF → (back to the beginning)

- SURROUND ON is selected when playing a video with audio recorded in Dolby Pro Logic, Dolby digital, or DTS digital surround audio.

Note:

- It is possible to select only “SURROUND ON” and “SURROUND OFF” when playing a Dolby digital audio or DTS digital audio DVD.

On the front panel:

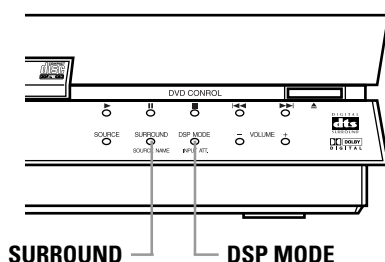

SURROUND DSP MODE

When playing a video with audio recorded in Dolby surround, Dolby

digital, or DTS digital surround audio:

Press SURROUND.

The current status appears on the display when the button is pressed, and changes between SURROUND ON and SURROUND OFF each time the button is pressed subsequently.

When selecting DAP:

Press DSP MODE.

The currently selected DAP mode appears on the display when the button is pressed, and changes as follows each time the button is pressed subsequently.

→ THEATER → LIVE CLUB → DANCE CLUB → HALL → PAVILION → DSP OFF → (back to the beginning)

Notes:

- “PRO LOGIC”, rather than “SURROUND ON”, is displayed when a source other than DVD is selected.
- The down-mixed (Lo/Ro*) analog signal is output from the VCR OUT (REC) terminal and TAPE/MD OUT (REC) terminal at the rear of the center unit when “SURROUND OFF” is selected with Dolby digital or DTS digital surround audio.
- When the DSP mode is ON, the VCR OUT (REC) jack and the TAPE/MD OUT (REC) jack will output surround sound to the front speakers only.
When recording, turn the DSP mode OFF.

* Lo/Ro refers to the downmix output when connected to a device that does not use a Dolby Pro Logic decoder.

Using the DVD player

DVD **Audio CD** and **Video CD** represent disc types.

To play a disc

On the front panel

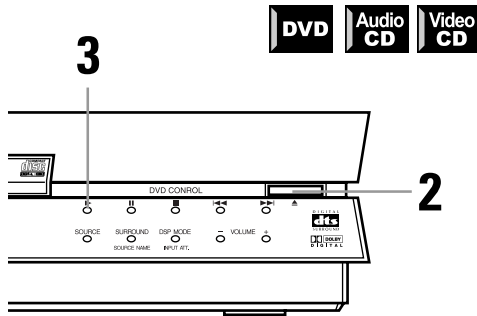

1. Switch the TV on and display video from this system.

Set the TV input to video 1 (or video 2 or 3).

2. Insert the disc.

① Press **▲** * on the center unit to open the disc tray.

Change the playback source to DVD.

② Place the disc in the tray.

With the playback side (non-label side) down.

To insert an 8 cm disc, place it in the inner recess.

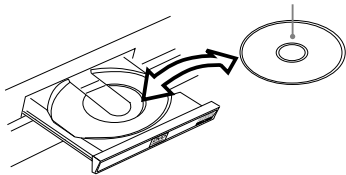

③ Press **▲** to close the disc tray.

Playback begins immediately a DVD auto-playback disc is inserted.

3. Play the disc.

From the remote controls:

Press **DVD**.

Change the playback source to DVD. The remote control enters the DVD mode and playback begins.

Primary remote control

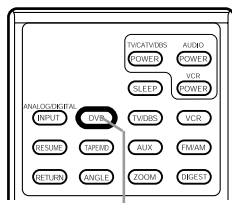

DVD

Secondary remote control

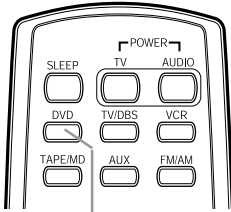

DVD

On the front panel:

Press **▶****.

Change the playback source to DVD. Playback begins.

- * When **▲** on the center unit is pressed while on standby, power is automatically turned on and the disc tray ejected.
- ** When **▶** on the center unit is pressed while on standby, power is automatically turned on, and playback begins, if a disc is in the tray.
DVD is selected as the playback source if there is no disc in the tray.

Notes:

- The unit can playback DVD VIDEO, Audio CD, and Video CD discs only. Do not load other disc types.
For details about playable disc types, see page 5.
- When loading a disc in the tray, be sure to position the disc inside the recess. Otherwise, the disc may be damaged when the tray is closed, and the disc may not be removed from the unit.
- Playback begins automatically with some discs.
- DVD or video CDs recorded with PBC (playback control), pressing PLAY may display the menu on the TV screen. You may select items from the menu screen thus displayed and call up the locations to be viewed (see pages 24 and 25 for details).
- You can also open and close the disc tray from the opening on-screen display.
Use CURSOR **▲/▼** to move pointer to **△**, then press ENTER to open or close the disc tray.
- Discs may be played back from the on-screen menu.
Use the CURSOR **▲/▼**, move the pointer to **▷**, and press ENTER to begin playback.

To stop playback completely

From the remote controls: Press **STOP**.

On the front panel: Press **■**.

Display when a disc is inserted

When a DVD is inserted

Display window:

“READING” → “DVD”

Opening on-screen:

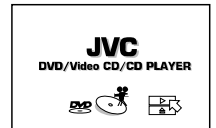

When a video CD has been inserted

Display window:

“READING” → “VCD 12 48:12”

(total number of tracks and total time display)

↓ ← After 4 seconds

“VCD 1 4:12”

(first track time)

Opening on-screen:

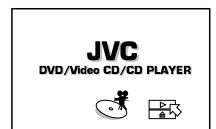

When an audio CD has been inserted

Display window:

“READING” → “CD 12 48:12”

(total number of tracks and total time display)

↓ ← After 4 seconds

“CD 1 4:12”

(first track time)

Opening on-screen:

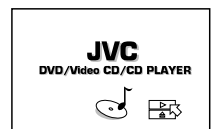

On-screen guide icons

During DVD playback, you may see icons displayed over the picture. These have the following meanings.



Displayed at the beginning of a scene recorded from multiple angles (see page 30).



Displayed at the beginning of a scene recorded with multiple audio languages (see page 32).



Displayed at the beginning of a scene recorded with multiple subtitle languages (see page 29).

A setting is possible to suppress display of these icons. The setting is entered in the on-screen menu under "DVD MENU Settings" (see page 46 for details).

About invalid operation icon

When you press a button, if the unit does not accept its operation, appears on your television screen.

Operations are occasionally unacceptable even if is not displayed.

Note that some operations may not be accepted. For example, some discs may not allow fast forward, fast backward or slow motion playback.

Pausing

From the primary remote control:

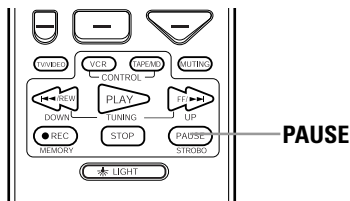

Press PAUSE.

On the front panel:

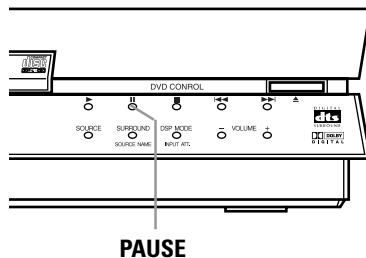

Press II.

Playback is paused.

Press PAUSE while paused to move to the next still picture.

To resume playback.

From remote control: Press PLAY.

On the front panel: Press ►.

Fast forward and rewind

■ During playback



From the remote controls:

Primary remote control

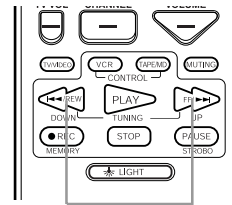

◀◀/REW, FF/▶▶

Secondary remote control

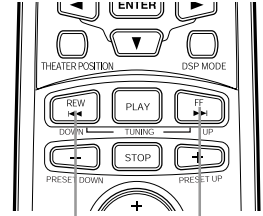

◀◀/REW, FF/▶▶

Continue pressing FF/▶▶ or ◀◀/REW.

On the front panel:

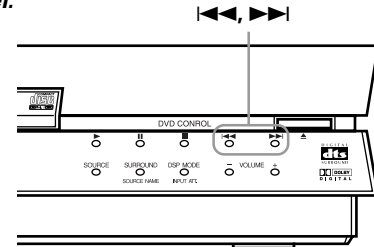

Continue pressing ▶▶ or ◀◀.

Continue pressing ▶▶ for fast forward.

Continue pressing ◀◀ for rewind.

Normal playback resumes when the button is released.

- Continue pressing the button to increase the fast forward or rewind speed (5x → 20x).

Locating the beginning



Locates the beginning of the title and chapter with DVDs.

Locates the beginning of the track with audio CDs and video CDs.

■ For DVD: During playback

For Audio CD: Any time

For Video CD: During playback

From the remote controls:

Primary remote control

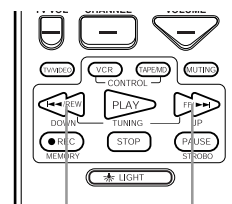

◀◀/REW, FF/▶▶

Secondary remote control

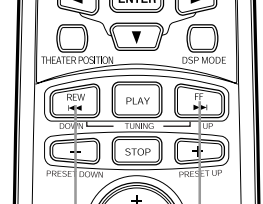

◀◀/REW, FF/▶▶

Press FF/▶▶ or ◀◀/REW.

On the front panel:

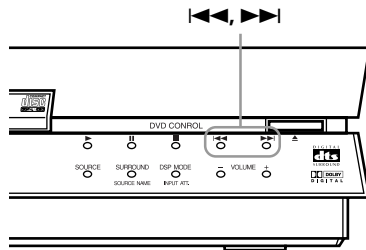

Press **▶▶▶** or **◀◀◀**.

Press **◀◀◀** to locate the beginning of the current chapter, title, or track, and press **▶▶▶** to locate the beginning of the next chapter, title, or track.

Note:

- When you play a Video CD disc with PBC function or a DVD disc, the unit may locate different place, but it will generally locate the beginning of the title or chapter or track.

Resuming playback

The unit stores the position on a disc where you want to interrupt playback at, and resumes playback from that position later.



To store the playback position

Primary remote control only:

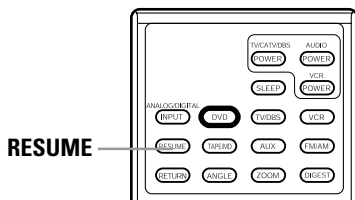

Press **RESUME** during playback.

The unit stores the position at which RESUME is pressed, and the RESUME indicator in the display window is lit. The last stored memory overrides the previous memory.

Note:

- The interrupted position is stored even when AUDIO POWER on the remote control, or POWER on the center unit, are pressed to switch power OFF (standby), instead of pressing RESUME.

To resume playback from the stored position

Press **RESUME** while paused.

Playback begins from the stored position.

- The unit will also resume playback when RESUME is pressed in the standby mode.

Note:

- When you press RESUME during playback of a Video CD disc with the PBC function, the unit may resume playback from a point slightly earlier than the resume point you stored.

To clear the stored position

Open the disc tray.

The RESUME indicator in the display window goes off.

Selecting playback from the DVD menu



DVD discs generally have their own menus which show the disc contents. These menus contain various items such as titles of a movie, names or songs, or artist information, and display them on the TV screen. You can locate a desired scene by using the menu.

- Insert the DVD disc.

From the remote controls:

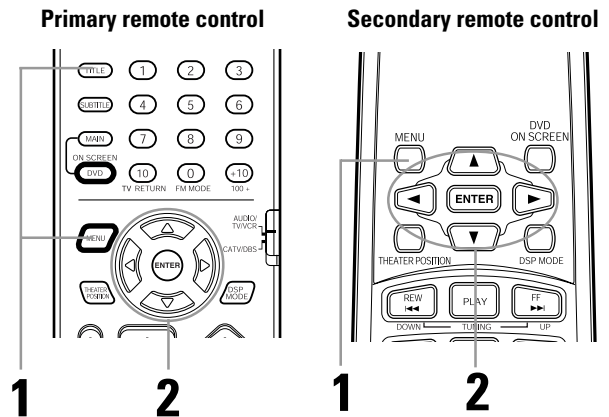

1. Press **MENU** or **TITLE**.

The menu appears on the TV screen.

- TITLE not on secondary remote control.

Example

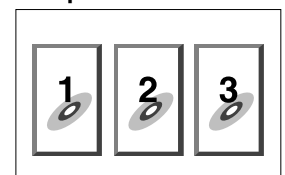

2. Use **CURSOR** **◀/▶/▲/▼** to select a desired item, then press **ENTER**.



The unit starts playback of the selected item.

- With some discs, you can also select items by entering the corresponding number using the number buttons, which may cause the unit to automatically start playback.

About menu

Normally, a DVD disc which contains more than one title may have a "title" menu which lists the titles. In this case, the menu appears on the TV screen by pressing TITLE. Some DVD discs may also have a different menu which appears by pressing MENU. See the instructions of each DVD disc for its particular menu.

Notes:

- When  appears on the TV screen by pressing TITLE in step 1: The disc does not have a menu listing the titles.
- When  appears on the TV screen by pressing MENU in step 1: The disc does not have a menu.

Selecting the location to view from the video CD menu

When playing back Video CDs recorded with PBC (playback control), a list of the recorded contents may appear on the TV screen as a menu. The location to view may be conveniently called up from this menu screen.



- When the menu appears on the TV screen during playback with PBC.

Primary remote control only:

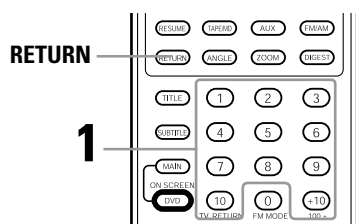

1. Use the number buttons (1~10, +10) to select the desired number of the item. **Example**

To select 3 on menu:

Press 3.

To select 11 on menu :

Press +10 → 1.

Playback starts from the selected item.

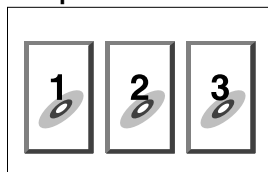

Press RETURN to return to the menu screen.

When “NEXT” or “PREVIOUS” appears on the TV screen, the unit generally works as follows:

- Pressing ►► turns to the next page.
- Pressing ◀◀ returns to the previous page.

The method of the operation is different depending on the disc.

To activate the PBC function when a PBC-compatible Video CD disc is being played back without the PBC function, press STOP then press PLAY.

You can also activate the PBC function using the on-screen display as follows.

1. Press **DVD ON SCREEN**.
2. Use **CURSOR ▲/▼** to move the pointer to [PBC CALL], then press **ENTER**.

If you want to playback a PBC-compatible Video CD disc without activating the PBC function, start playback by using the number buttons instead of the PLAY button.

To specify the title or track number for playback

Use the number buttons to specify the title (DVDs) or track number (CDs) to begin playback from the desired location.



- For DVD: While stopped
- For Audio CD: During playback or while stopped
- For Video CD: During playback without PBC function or while stopped

Primary remote control only:

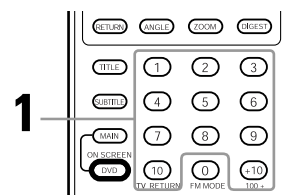

1. Use the number buttons (1~10, +10) to select the desired title or track number.

Selecting numbers

Selecting 1~10:

Press the relevant button between 1 and 10.

Selecting 11 or higher:

To select 13: Press +10 → 3 .

To select 24: Press +10 → +10 → 4.

To select 40: Press +10 → +10 → +10 → 10.

The specified title or track number appears in the display window, and playback begins from that location.

- You can also see the selected title or track number on the on-screen display.

Notes:

- When appears on the TV screen. The title or track you have selected is not contained in the disc.
- This function does not work during Video CD playback with PBC function.

To play from the beginning of a title, chapter, or track

The beginning of previous or later chapters or tracks may be skipped.



- For DVD: During playback
- For Audio CD: Any time
- For Video CD: During playback without PBC function

Common:

Primary remote control

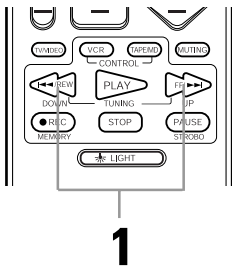

Secondary remote control

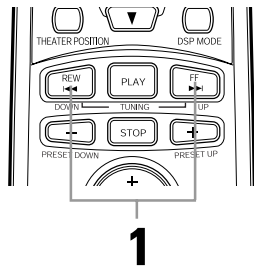

1. Press ►► or ◀◀.

- Press ►► the required number of times to move to a later chapter or track.
- Press ◀◀ the required number of times to return to the previous chapter or track.
- Press ◀◀ once to return to the beginning of the chapter or track currently playing.

Notes:

- This function may not work with some DVD discs.
- This function does not work during Video CD playback with PBC function.
- Press ►► or ◀◀ on the center unit for the same operation.

To specify the chapter number for playback [CHAP. SEARCH]

If the current title of a DVD disc being played is divided into chapters, you can skip to a desired chapter by specifying the chapter number using the on-screen display.



- During playback

From primary remote control only:

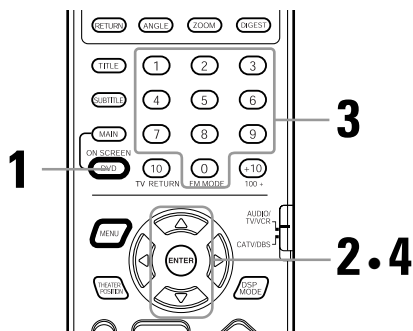

1. Press DVD ON SCREEN.

The on-screen display appears on the TV screen.

2. Use CURSOR ▲/▼ to move the pointer to [CHAP. SEARCH], then press ENTER.

The color of [CHAP. SEARCH] changes and “GO TO CHAPTER:” appears in the message area.

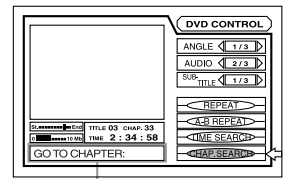

Message area

3. Use the number buttons (0-9) to enter the desired chapter number.

The selected chapter number appears in the message area.

Example:

- To select chapter number 8: Press 8.
- To select chapter number 37: Press 3 → 7.

4. Press ENTER.

The unit starts playback from the selected chapter.

To return the regular display:

Press DVD ON SCREEN.

Notes:

- **When the chapter number is incorrect in step 3:**
Overwrite the incorrect number with the correct number.
- **When ⊘ is displayed in the TV screen in step 4:**
The chapter you have selected is not contained in the disc, or chapter search does not work on the disc.
- With some discs, the unit automatically starts searching for the chapter after entering the chapter number in step 3.

To specify the time for playback [TIME SEARCH]

You can play a disc from the desired position by specifying the elapsed time from the beginning of the disc use the TIME SEARCH function.



Note that some DVD discs do not contain time information, and the TIME SEARCH function cannot be used.

- For DVD: During playback
- For Audio CD: While stopped
- For Video CD: While stopped without PBC function

From primary remote control only:

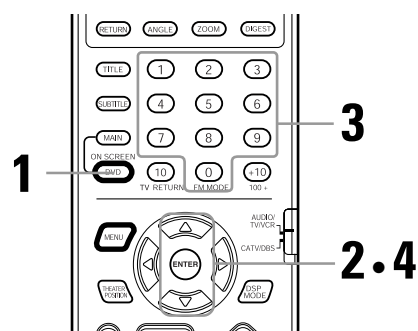

1. Press DVD ON SCREEN.

The on-screen display appears on the TV screen.

2. Use CURSOR ▲/▼ to move the pointer to [TIME SEARCH], then press ENTER.

The color of [TIME SEARCH] changes and "GO TO:" appears in the message area.

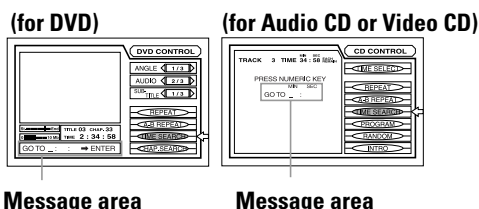

3. Use the number buttons (0~9) to enter the time.

The specified time appears in the message area.

Example (for DVD):

To playback from 2(H):34(M):00(S)

You do not have to press "0" to enter the trailing zeros (for the last two digits in the example above). Of course, it is possible to enter them.

- You can specify the time in hour/minute/second format for DVD discs, and in minute/second format for Audio and Video CD discs.

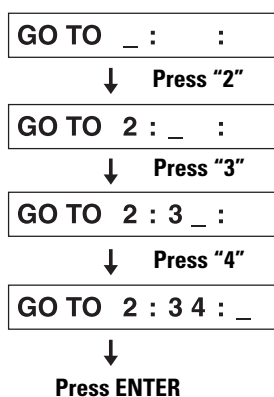

When you make a mistake

Use CURSOR ◀ to move the cursor to an incorrect number and enter the correct number.

4. Press ENTER.

The unit starts playback from the selected time.

To return to the regular display:

Press DVD ON SCREEN.

Note:

- When ⊗ appears on the TV screen in step 2:

The time you have selected is not contained on the disc, or the TIME SEARCH function does not work on the disc.

Also note that the TIME SEARCH function does not work during Video CD playback with the PBC function.

To select the screen for playback from the digest screen [DIGEST]

The unit can display the opening scene of each title or chapter on a DVD or each track of a Video CD.



You can select a desired title, chapter or track from the opening scenes displayed on the TV screen.

- For DVD: While stopped or during playback
- For Video CD: While stopped or during playback without PBC function.

From primary remote control only:

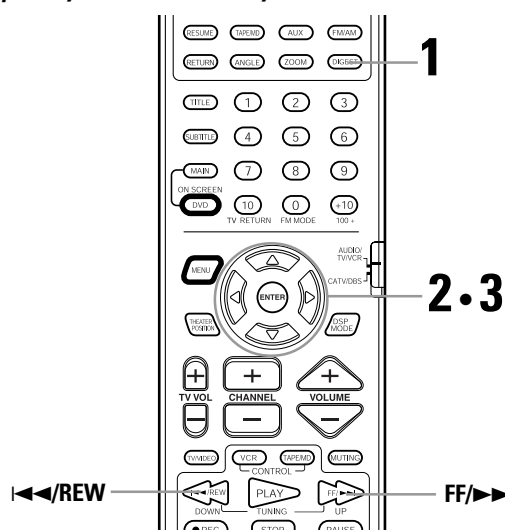

1. Press DIGEST.

- DVD is stopped**

Up to nine first scenes of each title may be displayed.

- DVD is playing**

Up to nine first scenes of each chapter in the current title may be displayed.

- Video CD**

Up to nine first scenes of each track may be displayed.



2. Use CURSOR ◀/▶/▲/▼ to select the desired title, chapter or track.

When the disc contains more than 9 titles or tracks, the digest screen will have more than one page.

In this case, display a different page of the digest with the method described below.

To display the next page: Press ▶▶.

To display the previous page: Press ◀◀.

Or

When the selected title or track is in the upper left-hand corner of the screen, pressing CURSOR ◀.



When the selected title or track is in the lower right-hand corner of the screen, pressing CURSOR ▶.

3. Press ENTER.

The unit starts playback from the selected title, chapter or track.

To return to the regular display:

Press DIGEST.

Note:

- With some discs, depending on the contents, it may take some time until all the scenes appear on the screen.

To advance the picture one frame at a time

Advancing a paused still picture one frame at a time.



- During playback

From primary remote control only:

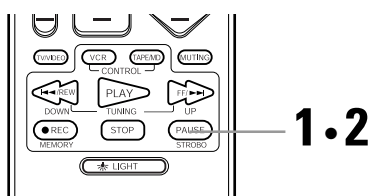

1. Press PAUSE at the location at which the picture is to be advanced.

The picture is paused.

2. Press PAUSE.

Each time you press PAUSE, the still picture advances to the next frame.

Press PLAY to return to normal playback.

Note:

- You can perform the above operation using **II** button on the center unit.

Slow-Motion Playback [SLOW]

- During playback



From primary remote control only:

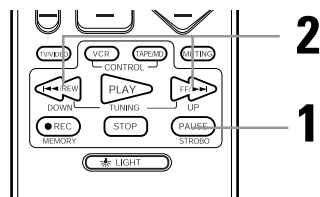

1. Press PAUSE at the section you wish to view in slow motion.

The image will pause.

2. Hold down FF/PAUSE or REW/PAUSE for more than 2 seconds.

Hold down FF/PAUSE will playback your selection in slow motion, starting from the pause frame.

Hold down REW/PAUSE will playback your selection in reverse slow motion (DVD only).

Each time you hold down either button during slow-motion, the playback speed will increase as follows:

Forward: 1/32 → 1/16 → 1/8 → 1/4 → 1/3 → 1/2

Reverse: 1/16 → 1/12 → 1/8 → 1/4 → 1/3

Pausing slow-motion playback

Press the PAUSE button to pause slow-motion playback.

Restoring regular playback

Press the PLAY button to resume normal playback.

Notes:

- Audio is automatically muted during slow-motion playback.
- Video CDs cannot be played in reverse slow-motion.
- You can perform the above operations using **II**, **▶▶▶**, and **◀◀◀** buttons on the center unit.

To display Continuous Photos [STROBE]

Nine still pictures may be displayed one after the other.



- During playback

From primary remote control only:

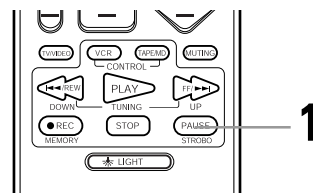

1. Press PAUSE continuously to display continuous photos.

When the screen appears displaying the nine pictures, release the PAUSE button.

The screen plays back the nine pictures in strobe-like action.

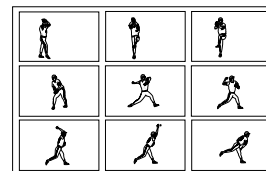

- Press PAUSE during strobe playback to pause. Press PAUSE to display the next nine still pictures. Press PLAY to resume strobe playback.

To clear the strobe screen, press PAUSE continuously until the normal screen appears.

Note:

- Audio is not played during strobe playback.

Zooming a scene [ZOOM]

■ During playback or while paused.



From primary remote control only:

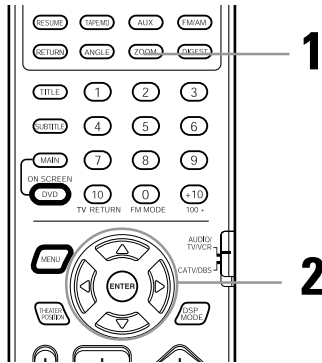

1. Press ZOOM.

“ZOOM” appears on the TV screen.

The unit zooms in to the center part of the scene to produce a double-sided image.

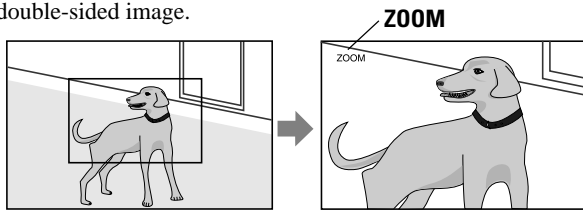

2. Use CURSOR $\leftarrow/\rightarrow/\uparrow/\downarrow$ to move the zoomed-in scene.

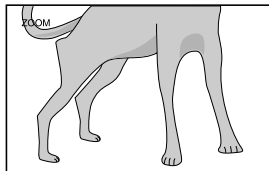

To pause zoom play

Press PAUSE.

To resume zoom play, press PLAY.

To return to normal playback

Press ZOOM.

Note:

- During Zoom play, the picture may be garbled or noisy.

Changing the Subtitle Language [SUB TITLE]

Some DVD discs contain subtitles. With such discs, you can choose which kind of subtitles to display (or turn off subtitles entirely). At the beginning of subtitled parts,  appears on the TV screen.



Using the SUBTITLE button

■ During playback

From primary remote control only:

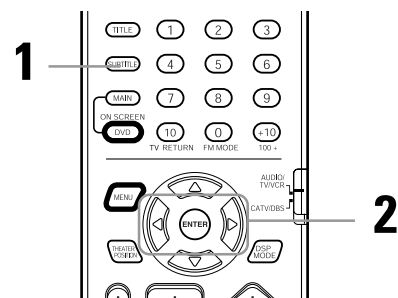

1. Press SUBTITLE.

2. Use CURSOR \leftarrow/\rightarrow to select the desired subtitle.

Turning subtitles ON/OFF

Press SUBTITLE.

Pressing the button toggles subtitle display ON and OFF.

Note:

- When  appears on the TV screen: You cannot select the subtitle.

To change subtitle display using the on-screen display

■ During playback

From remote control:

Primary remote control

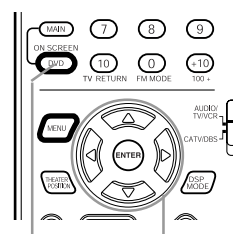

Secondary remote control

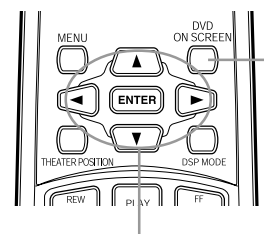

1. Press DVD ON SCREEN.

The on-screen display appears on the TV screen.

2. Use CURSOR ▲/▼ to move the pointer [SUBTITLE].

3. Use CURSOR ◀/▶ to select the desired subtitle.
Each time you press CURSOR ◀/▶, the subtitle changes.

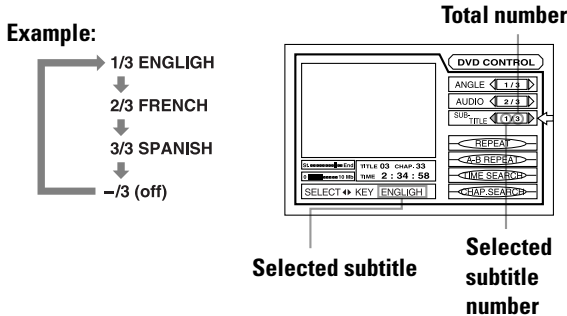

To turn off the on-screen display
Press DVD ON SCREEN.

Note:

- The selected language may abbreviated on the TV screen. See “Appendix A: Table of languages and their abbreviations” in this manual.

Changing the audio language or sound [AUDIO]

Some DVD discs contain multiple audio tracks. With such discs, you can choose which audio track to listen to during playback.



At the beginning of “multi-audio language” parts, appears on the TV screen.

■ During playback

From the remote controls:

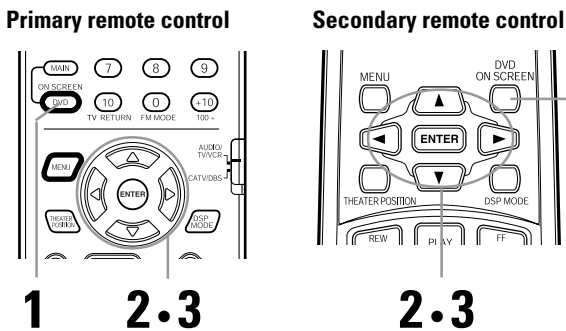

- 1. Press DVD ON SCREEN.**
The on-screen display appears on the TV screen.
- 2. Use CURSOR ▲/▼ to move the pointer to [AUDIO].**

3. Use CURSOR ◀/▶ to select the desired audio language or sound.

Each time you press CURSOR ◀/▶, the audio language or sound changes.

Example:

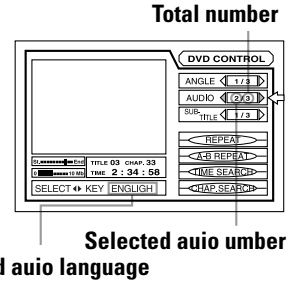
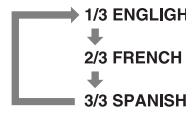

To turn off the on-screen display
Press DVD ON SCREEN.

Note:

- When appears on the TV screen:
You cannot select the audio.

Changing the audio channel [AUDIO]

For in some karaoke Video CDs, one of the audio channels includes a vocal while the other does not.



With such discs, you can choose to enjoy karaoke without the vocal or with the vocal by selecting the audio channel to be played back.

■ During playback

From the remote controls:

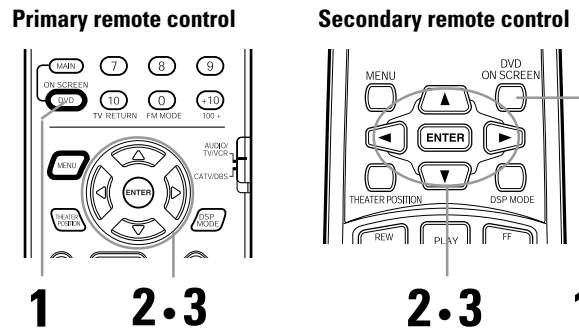

- 1. Press DVD ON SCREEN.**
The on-screen display appears on the TV screen.
- 2. Use CURSOR ▲/▼ to move the pointer to [AUDIO].**
- 3. Select the audio channel(s) to be played back using CURSOR ◀/▶.**

L/R: You hear normal stereo playback.

L: You hear the L (Left) channel signal played back from both the left and right speakers.

R: You hear the R (Right) channel signal played back from both the left and right speakers.

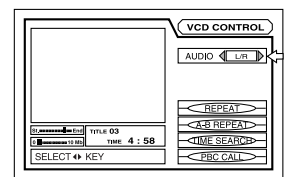

To turn off the on-screen display
Press DVD ON SCREEN.

Viewing from Multiple Angles [ANGLE]

You can enjoy a variety of scene angles if the DVD disc contains “multi-angle” parts, where multiple cameras were used to shoot the same scene from different angles. You can select one of these viewing angles from the normal screen or on-screen display.



At the beginning of “multi-angle” parts, appears on the TV screen.

Using the ANGLE button

■ During playback

From primary remote control only:

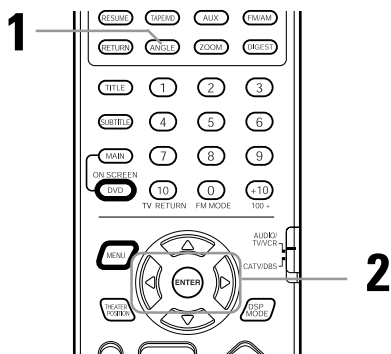

1. Press ANGLE.
2. Press ANGLE or CURSOR to select the desired angle.

Each time you press ANGLE or CURSOR , the angle changes.

Selecting an angle from the angle list display

■ During playback

From primary remote control only:

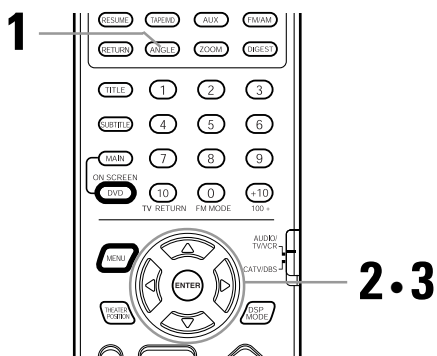

1. Press and hold ANGLE for more than 1 seconds.

Up to nine camera angle recorded on a disc appear on the TV screen.

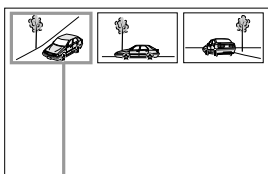

The selected camera angle

2. Use CURSOR to select the desired angle.

3. Press ENTER.

The selected angle appears on the TV screen.

Selecting a scene angle from the on-screen display

■ During playback

From the remote controls:

Primary remote control

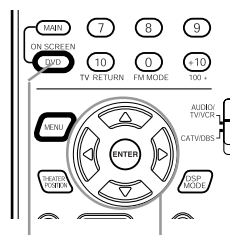

Secondary remote control

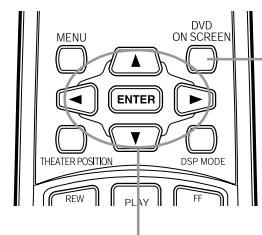

1. Press DVD ON SCREEN.

The on-screen display appears on the TV screen.

2. Use CURSOR to move the pointer to [ANGLE].

3. Use CURSOR to select the desired angle number.

The total number of recorded angles

Example:

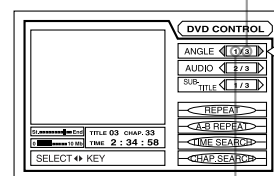
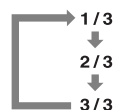

The current angle number

To turn off the on-screen display

Press DVD ON SCREEN.

Note:

- When appears on the TV screen

The current scene is not recorded from multiple angles.

Selecting the Picture Character [THEATER POSITION]

You can select the quality of the image from among four options (OFF, 1, 2, and 3) according to the type of programming, picture tone or personal preferences.



■ During playback

From the remote controls:

Primary remote control

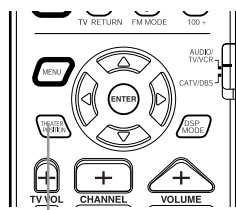

1

Secondary remote control

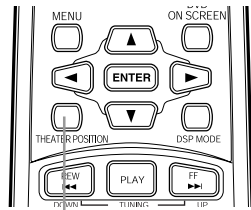

1

1. Press THEATER POSITION to select the desired picture character.

Each time you press the button, the picture character changes as follows:

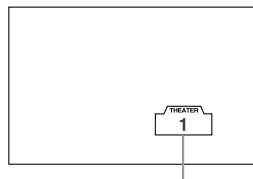

Selected effect mode

“OFF” is the normal position.

Selecting a higher number results in a darker picture character.

Press ENTER to close the THEATER POSITION screen.

- The THEATER POSITION screen will automatically close if left idle for more than 10 seconds.

Repeating a current title, chapter or track, or all tracks [REPEAT]

- For DVD: During playback
- For Audio CD: Any time
- For Video CD: During playback without PBC function.



From the remote controls:

Primary remote control

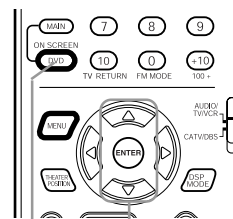

1

2

Secondary remote control

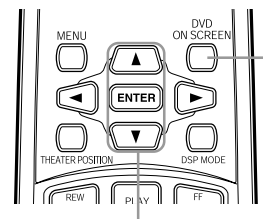

2

1

1. Press DVD ON SCREEN.

The on-screen display appears on the TV screen.

2. Use CURSOR ▲/▼ to move the pointer to [REPEAT], then press ENTER.

Each time you press ENTER, the repeat mode changes as follows:

For DVD

- T. REPEAT (title repeat)
- C. REPEAT (chapter repeat)
- No indication (off)
- (back to the beginning)

(for DVD)

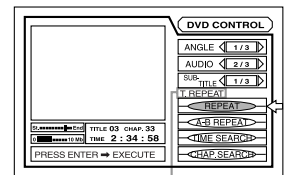

Selected repeat mode

The current title or chapter will be repeated.

For Audio CD and Video CD

- REPEAT ALL→REPEAT 1→No indication (off)→(back to the beginning)

(for Audio CD)

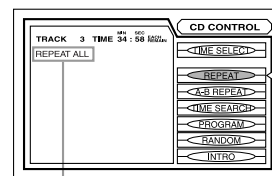

Selected repeat mode

(for Video CD)

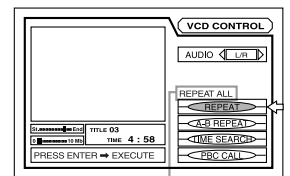

Selected repeat mode

REPEAT ALL : All the tracks are played repeatedly.

REPEAT 1 : The current track is played repeatedly.

The current track or all tracks is/are played repeatedly.

To stop repeat playback

Press STOP.

- When a DVD disc is set, the unit stops playback and quits repeat mode.
- When an Audio or Video CD is set, the unit stops playback but remains in repeat mode.

To quit repeat playback

Move the pointer to [REPEAT] and press ENTER repeatedly until the [REPEAT] display turns off.

To turn off the on-screen display

Press DVD ON SCREEN.

Notes:

- Repeat play function cannot be used during Video CD playback with PBC function.
- If  appears when pressing ENTER in step 2 during DVD playback
You cannot repeat the title or chapter because of the disc contents.

Repeating a desired part [A-B REPEAT]

■ During playback



From the remote controls:

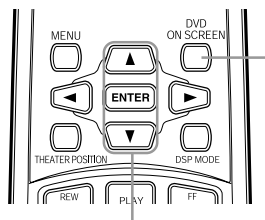
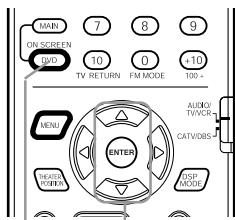

Primary remote control

Secondary remote control



1 2.3

2.3 1

1. Press DVD ON SCREEN.
The on-screen display appears on the TV screen.
2. Use CURSOR / to move the pointer to [A-B REPEAT], then press ENTER at the beginning of the part you want to repeat (point A).
The color of [A-B REPEAT] changes.
3. Press ENTER at the end of the part you want to repeat (point B).
The unit locates "A" and starts repeat playback between "A" and "B".

(for DVD)

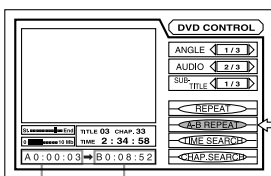

Point A Point B

(for Audio CD)

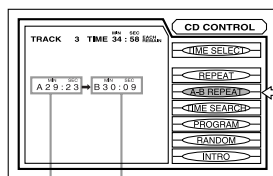

Point A Point B

(for Video CD)

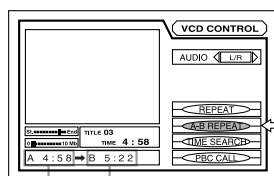

Point A Point B

To quit A-B repeat playback

Press STOP. The unit stops playback and quits A-B repeat mode.

Quitting A-B repeat mode without stopping playback

Move the pointer to [A-B REPEAT] and press ENTER.

To turn off the onscreen display

Press DVD ON SCREEN.

Notes:

- If  appears when pressing ENTER in step 2 during DVD playback.
You cannot repeat the selected portion because of the disc contents.

Sampling all tracks [INTRO]

You can sample the tracks of an Audio CD or Video CD by playing back only beginning 10 seconds of each track in order.



■ While stopped

From the remote controls:

Primary remote control

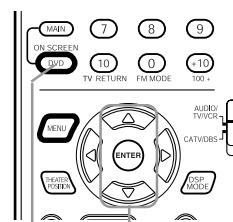

Secondary remote control

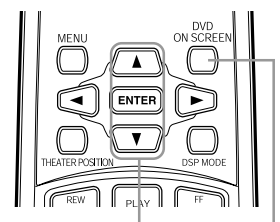

1 2



2 1

1. Press DVD ON SCREEN.
The on-screen display appears on the TV screen.
2. Use CURSOR / to move the pointer to [INTRO], then press ENTER.

(for Audio CD)

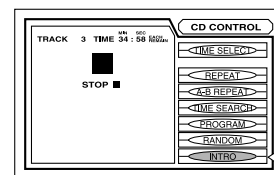

(for Video CD)

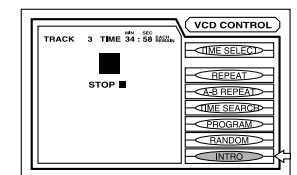

The first 10 seconds of each track on a disc are played back in numerical order from the first track. When all tracks have been played once, INTRO scan mode quits.

To quit INTRO scan

Press STOP. The unit stops and quits INTRO scan mode.

Quitting intro scan mode without stopping playback

Move the pointer to [INTRO] and press ENTER.

To turn off the on-screen display

Press DVD ON SCREEN.

Checking the Disc Time [TIME SELECT]

You can choose the displayed time mode for an Audio or Video CD disc in the display on the front panel and in the on-screen display.



- For Audio CD: Any time
- For Video CD: While stopped

From the remote controls:

Primary remote control

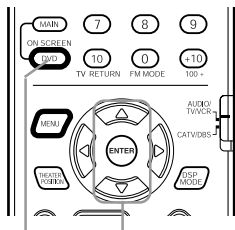

1 2.3

Secondary remote control

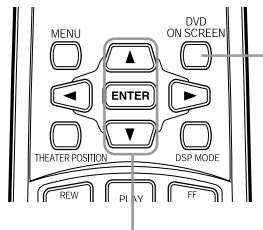

2.3 1

1. Press DVD ON SCREEN.

The on-screen display appears on the TV screen.

2. Use CURSOR ▲/▼ to move the pointer to [TIME SELECT].

(for Audio CD)

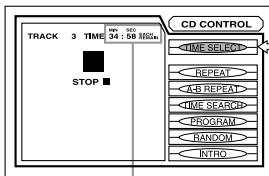

Time display

(for Video CD)

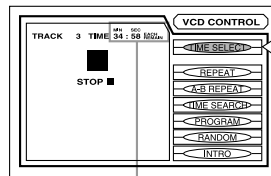

Time display

3. Press ENTER.

Each time you press ENTER, the time mode changes as follows:

• During playback (for Audio CD)

- ▶ EACH (Elapsed time of the current track)
- ▼ EACH REMAIN (Remaining time of the current track)
- ▼ TOTAL (Total elapsed time of the disc)
- ▼ TOTAL REMAIN (Total remaining time of the disc)

• While stopped

- ▶ EACH REMAIN (Remaining time of the current track)
- ▼ TOTAL (0:00)
- ▼ TOTAL REMAIN (Total remaining time of the disc)
- ▼ EACH (0:00)

Note:

- When you select "EACH REMAIN" while stopped, you can change the track by pressing ►► or ◀◀.

Programming the Playing Order of the Tracks [PROGRAM]

You can play tracks on an Audio CD or Video CD in the desired order.



- While stopped

From primary remote control only:

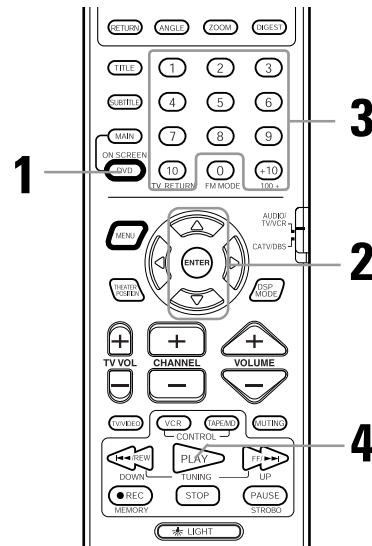

1. Press DVD ON SCREEN.

The on-screen display appears on the TV screen.

2. Use CURSOR ▲/▼ to move the pointer [PROGRAM] and press ENTER.

The color of [PROGRAM] changes.

(for Audio CD)

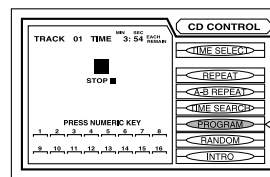

(for Video CD)

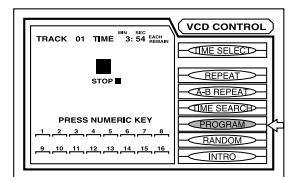

3. Select the tracks in the desired order using the number buttons (1~10, +10).

Up to 16 tracks can be programmed. You may select the same track more than once.

Selecting numbers

Selecting 1~10:

Press the relevant button between 1 and 10.

Selecting 11 or higher:

To select 13: Press +10 → 3 .

To select 24: Press +10 → +10 → 4 .

To select 40: Press +10 → +10 → +10 → 10 .

Selected track number

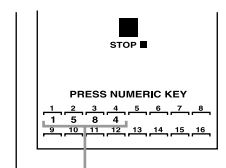

If you mistakenly select the wrong track number press STOP to delete the entered program. Then reselect the tracks you wish.

4. Press **PLAY** to start program play.

When all of the programmed tracks have finished playback, the unit stops but the program remains.

To turn off the on-screen display

Press DVD ON SCREEN.

Quitting programmed playback

Move the pointer to [PROGRAM] and press ENTER.

[PROGRAM] will turn to its original color, and the program contents will be deleted.

Note:

- When playing an Audio CD or Video CD, if less than 16 tracks have been programmed, it is possible to add tracks during playback.

Random Play [RANDOM]

You can play tracks in random order.



- While stopped

From the remote controls:

Primary remote control

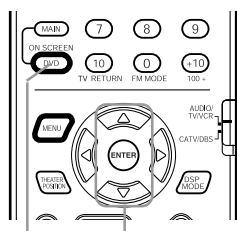

1 2 • 3

Secondary remote control

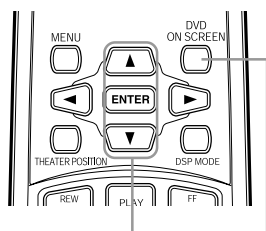

2 • 3 1

1. Press **DVD ON SCREEN**.

The on-screen display appears on the TV screen.

2. Use **CURSOR ▲/▼** to move the pointer [RANDOM].

(for Audio CD)

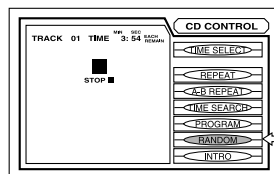

(for Video CD)

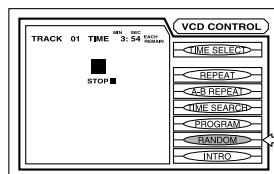

3. Press **ENTER**.

The color of [RANDOM] changes. Random play begins.

- When all tracks have been played once, random play ends.
- The same track will not be played back more than once during random play.

To turn off the on-screen display

Press DVD ON SCREEN.

To quit random playback

Press STOP.

Note:

- During random playback of an audio CD, moving the pointer to [RANDOM] and pressing ENTER will quit random playback and begin regular playback with the current track.

Receiving radio broadcasts

You can browse through all the stations or use the preset function to go immediately to a particular station.

IMPORTANT

When using the primary remote control, check to see if its remote control mode selector is set to the correct position:
To operate this center unit, set it to "AUDIO/TV/VCR" (except when selecting the DBS tuner as the source).

Tuning in stations manually

From the remote controls:

Primary remote control

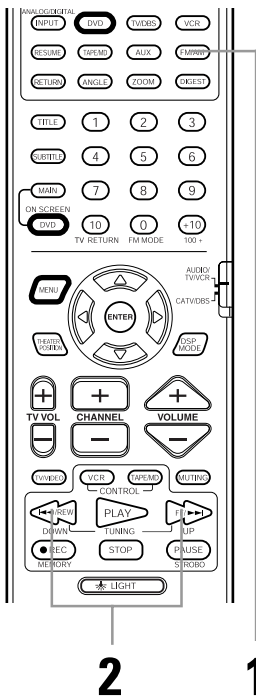

Secondary remote control

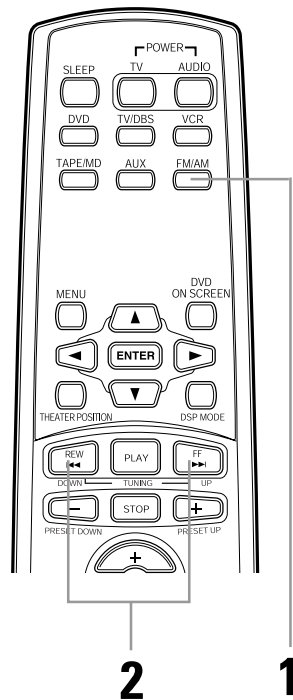

1. Press FM/AM to select the band.
 - Each time you press the button, the band alternates between FM and AM.
2. Press TUNING UP (FF/▶▶) or TUNING DOWN (◀◀/REW) repeatedly until you find the frequency you want.
 - When you hold the button, the frequency keeps changing until a station is tuned in.

Note:

- When a station of sufficient signal strength is tuned in, the TUNED indicator lights up on the display. When an FM stereo program is received, the STEREO indicator also lights up.

Using preset tuning

Once a station is assigned to a channel number, the station can be quickly tuned. You can preset up to 30 FM and 15 AM stations.

To store the preset stations

Before you start, remember...

- There is a time limit in doing the following steps. If the setting is canceled before you finish, start from step 1 again.

Primary remote control only:

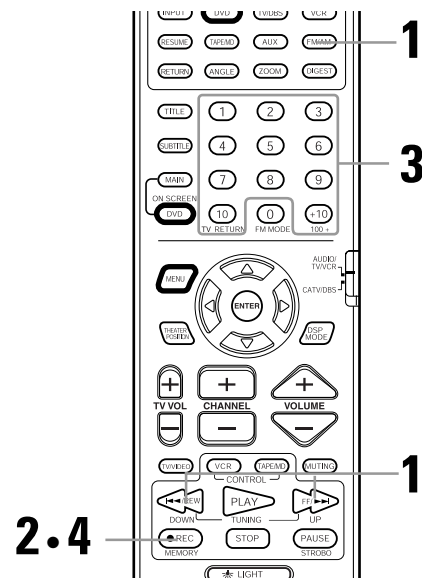

1. Tune in the station you want to preset (see "Tuning in stations manually").
 - If you want to store the FM reception made for this stations, select the FM reception mode you want. See "Selecting the FM reception mode" on page 37.
2. Press MEMORY (● REC).
"CH-" appears and the channel number position starts flashing on the display window for about 10 seconds.
3. Use the number buttons (1~10, +10) to select a channel number while the channel number position is flashing.
 - For channel number 5, press 5.
 - For channel number 15, press +10 → 5.
 - For channel number 20, press +10 → 10.
 - For channel number 30, press +10 → +10 → 10.
4. Press MEMORY (● REC) again while the selected channel number is flashing on the display window.
The selected channel number stops flashing.
The station is assigned to the selected channel number.
5. Repeat steps 1 to 4 until you store all the stations you want.

To erase a stored preset station

Storing a new station on a used number erases the previously stored one.

To tune in a preset station

From primary remote control:

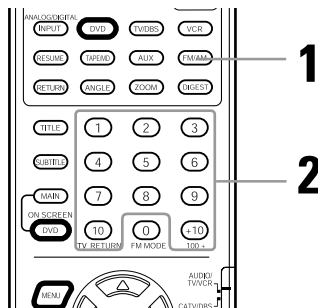

1. Press FM/AM.

- Each time you press the button, the band alternates between FM and AM.

2. Press the number buttons (1~10, +10) to select a preset channel number.

- For channel number 5, press 5.
- For channel number 15, press +10 → 5.
- For channel number 20, press +10 → 10.
- For channel number 30, press +10 → +10 → 10.

From secondary remote control:

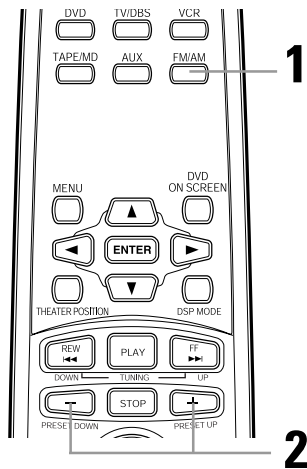

1. Press FM/AM.

- Each time you press the button, the band alternates between FM and AM.

2. Press PRESET UP (+) or PRESET DOWN (-) to select the desired preset number.

Selecting the FM reception mode

When an FM stereo broadcast is hard to receive or noisy

You can change the FM reception mode while receiving an FM broadcast.

- You can store the FM reception mode for each preset station.

From primary remote control:

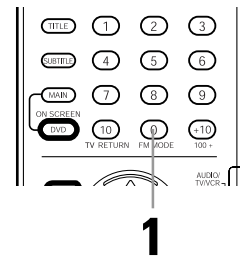

1. Press FM MODE.

- Each time you press the button, the FM reception mode alternates between “AUTO” and “MONO.”

AUTO: When a program is broadcasted in stereo, you will hear stereo sound; when in monaural, you will hear monaural sounds. This mode is also useful to suppress static noise between stations. The AUTO MUTING indicator lights up on the display.

MONO: Reception will be improved although you will lose the stereo effect. In this mode, you will hear noise while tuning into the stations. The AUTO MUTING indicator goes off on the display.

Beat cut

When listening to an AM broadcast with a lot of noise interference, you can change the BEAT CUT mode by pressing FM MODE.

Each time you press FM MODE, operation toggles between “BEAT CUT 1” and “BEAT CUT 2”.

Choose the setting that gives the clearest sound.

Performing miscellaneous settings

It is possible to perform a variety of settings from the on-screen display.

The two on-screen displays used for settings are the AV amplifier settings on-screen display and the DVD settings on-screen display. Only the primary remote control can be used on the MAIN MENU, SOUND MENU, and SPEAKER MENU found on AV amplifier settings screen.

Either the primary or secondary remote can be used on the DVD MENU found on the DVD settings screen.

AV amplifier settings on-screen display

The following menus are available from the on-screen AV Amp settings.

MAIN MENU

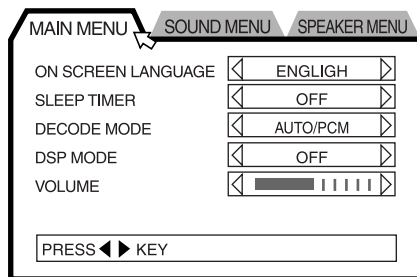

SOUND MENU

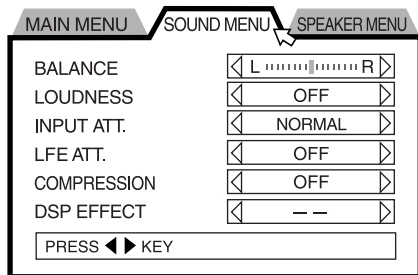

SPEAKER MENU

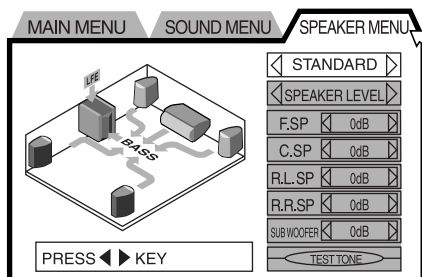

DVD settings on-screen display

The following menu is available from the on-screen DVD settings.

DVD MENU

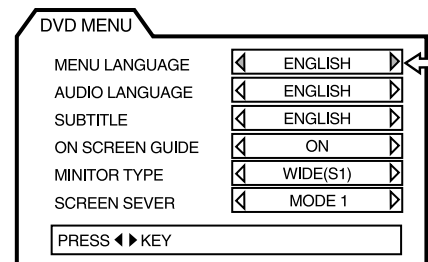

MAIN MENU Settings

Use the primary remote control to perform MAIN MENU settings.

Buttons used

MAIN ON SCREEN and the ◀/▶/▲/▼ cursors.

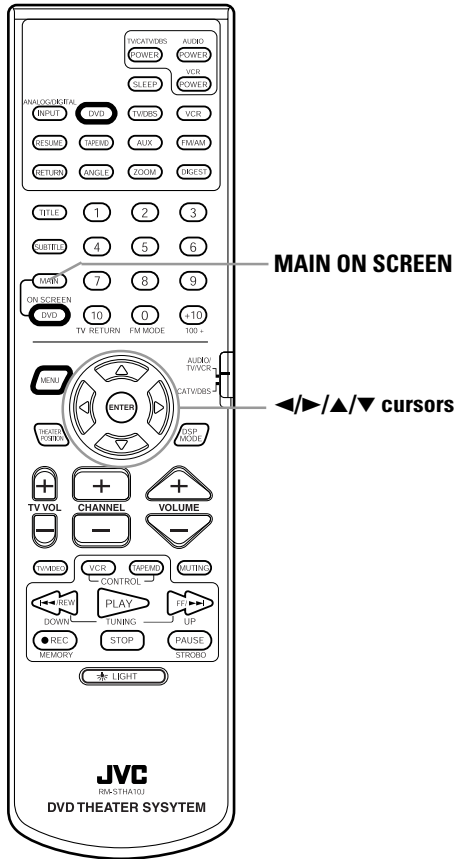

ON SCREEN LANGUAGE

The on-screen language is the language used in the display for the MAIN MENU, SOUND MENU, SPEAKER MENU, and DVD MENU.

The on-screen language is set to ENGLISH. The ON SCREEN LANGUAGE option is not available on this system.

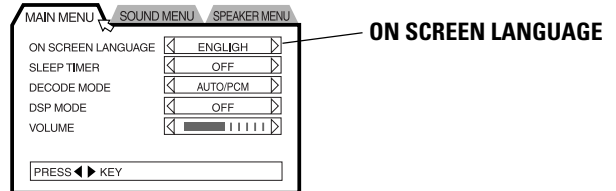

Setting the SLEEP TIMER

(See page 20)

1. Open the MAIN MENU.
See "Opening the MAIN MENU"
2. Move the pointer to SLEEP TIMER using the ▲/▼ cursors.

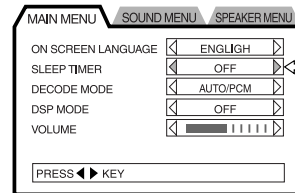

Opening the MAIN MENU

1. Stop DVD image playback on the TV screen.
Select a playback source other than the tuner. If the playback source is set to DVD, press STOP to quit playback.
2. Press MAIN ON SCREEN.
The MAIN MENU is displayed.

Referred to as a "tag"

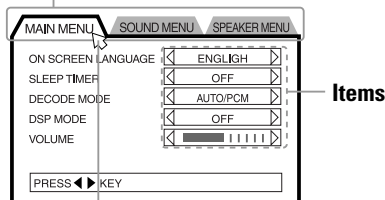

This arrow is referred to as a "pointer".

3. When you are finished with on-screen settings, press MAIN ON SCREEN again to close the MAIN MENU.

3. Use the ◀/▶ cursors to set the sleep time.
Select the sleep time in minutes from the following:
OFF ↔ 10 ↔ 20 ↔ 30 ↔ 60 ↔ 90 ↔ 120 ↔ 150
- If the SLEEP TIMER has already been set, you can confirm or change the remaining time here.

Changing the DECODE MODE

(See page 18)

This option is used to change the digital audio decode mode. The default setting of [AUTO/PCM] is recommended for regular use.

When the playback source is DVD, you may select a DECODE MODE.

1. Open the MAIN MENU

See page 39, "Opening the MAIN MENU".

2. Move the pointer to DECODE MODE using the ▲/▼ cursors.

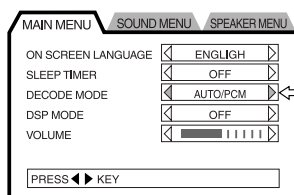

3. Use the ◀/▶ cursors to set the decode mode.

The following decoding options are available: AUTO/PCM, DOLBY DIGITAL, or DTS.

- See page 18 for details of each in decode mode.

Note:

- Only audio for discs for the selected decode mode may be played when a decode mode other than "AUTO/PCM" is selected. When the decode mode is changed and a disk has been played back, return the decode mode to "AUTO/PCM".

Changing the DSP MODE

(See page 20)

1. Open the MAIN MENU.

See page 39, "Opening the MAIN MENU".

2. Move the pointer to DSP MODE using the ▲/▼ cursors.

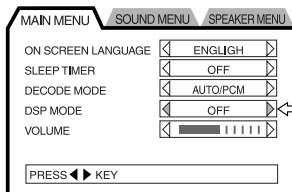

3. Use the ◀/▶ cursors to set the DSP mode.

When the source is DVD:

You may choose between "SURROUND" ↔ "OFF"

When the source is not DVD or TUNER*:

You may choose between

↔ SURROUND ↔ THEATER ↔ LIVE CLUB ↔ DANCE CLUB
↔ HALL ↔ PAVILION ↔ OFF ↔ (back to the beginning)

* When the source is set to tuner, the MAIN MENU will not be displayed.

Adjusting the volume

(See page 16)

1. Open the MAIN MENU.

See page 39, "Opening the MAIN MENU".

2. Move the pointer to VOLUME using the ▲/▼ cursors.

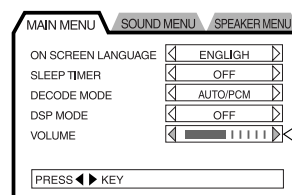

3. Use the ◀/▶ cursors to adjust the volume level.

Press ▶ to increase the volume.

Press ◀ to decrease the volume.

SOUND MENU Settings

Use the primary remote control to perform SOUND MENU settings.

Buttons used

MAIN ON SCREEN and the ◀/▶/▲/▼ cursors.

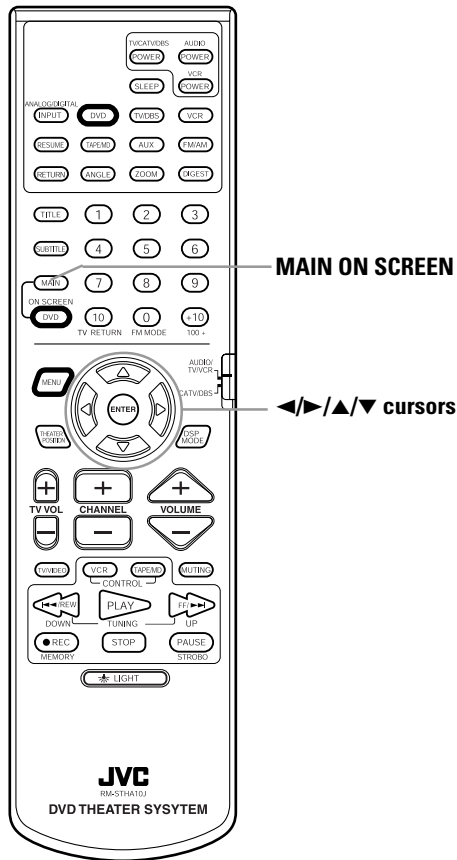

Adjusting the balance

Adjusting the front speaker balance.

1. **Open the SOUND MENU.**
See "Opening the SOUND MENU".
2. **Move the pointer to BALANCE using the ▲/▼ cursors.**

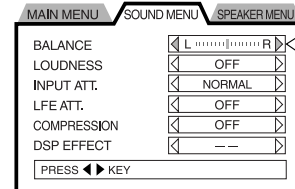

3. **Use the ◀/▶ cursors to adjust the balance.**
Press ◀ to shift the balance to the left.
Press ▶ to shift the balance to the right.

Using loudness

When listening to audio at low volume, sounds in the highest and lowest frequencies become difficult to hear. Turning loudness ON augments low and high frequency ranges for a fuller sound at low volume.

1. **Open the SOUND MENU.**
See "Opening the SOUND MENU".
2. **Move the pointer to LOUDNESS using the ▲/▼ cursors.**

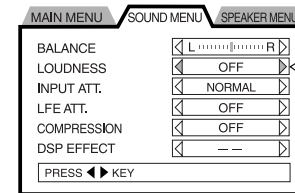

3. **Use the ◀/▶ cursors to select ON or OFF.**
Pressing ◀/▶ toggles loudness ON/OFF.

Opening the SOUND MENU

1. **Stop DVD image playback on the TV screen.**
Select a playback source other than the tuner. If the playback source is set to DVD, press STOP to quit playback.
2. **Press MAIN ON SCREEN.**
The MAIN MENU will be displayed.
3. **Move the pointer to the SOUND MENU tag using the ◀/▶ cursors.**

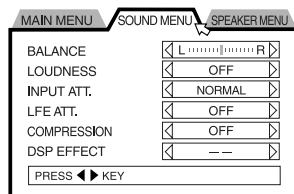

4. **When you are finished with on-screen settings, press MAIN ON SCREEN again to close the SOUND MENU.**

Adjusting input signal

(See page 19)

When using the DSP mode effect during playback from an analog device, the sound will occasionally be distorted due to a overly-strong input signal. In these instances, it is possible to adjust the level of the input signal. Only input signals from analog devices (TV SOUND, VCR, TAPE, AUX, MD, DBS) may be adjusted in this way.

1. Open the SOUND MENU.

See page 41, "Opening the SOUND MENU".

2. Move the pointer to INPUT ATT. using the ▲/▼ cursors.

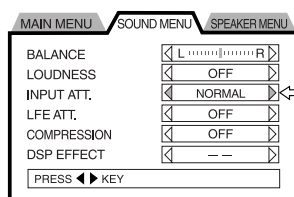

3. Use the ◀▶ cursors to select ON or NORMAL.

Pressing ◀▶ toggles loudness ON or NORMAL.

ON : Recommended to reduce sound distortion.

NORMAL : Default setting.

Notes:

- This setting does not affect digital signals.
- When in ON mode, ATT will light up in the display window. However, when the playback source is digital (DVD, etc.) it will go off. Lighting up will resume if playback is switched to an analog device.
- Even while in ON mode, if the DSP mode is turned off ("DSP OFF"), playback will continue without any reduction of the input signal.

Adjusting the sub-woofer output level

When the sub-woofer output level is too high, use the LFE Attenuator to lower the output level.

1. Open the SOUND MENU.

See page 41, "Opening the SOUND MENU".

2. Move the pointer to LFE ATT. using the ▲/▼ cursors.

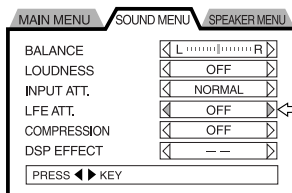

3. Use the ◀▶ cursors to select ON or OFF.

Pressing ◀▶ toggles loudness ON/OFF.

ON : Recommended to reduce sound distortion.

NORMAL : Default setting.

Adjusting the dynamic range

It is possible to compress the dynamic range (the difference between the loudest and quietest audio signals).

This is useful when enjoying surround sound at nighttime.

This function is only available when the source is recorded in Dolby Digital.

1. Open the SOUND MENU.

See page 41, "Opening the SOUND MENU".

2. Move the pointer to COMPRESSION using the ▲/▼ cursors.

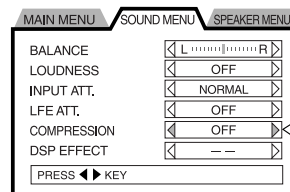

3. Use the ◀▶ cursors to switch between MID, LARGE, and OFF.

MID : Slightly compresses the dynamic range.

LARGE : Maximum compression of the dynamic range. (recommended for nighttime listening).

OFF : Choose this option to enjoy surround sound with the regular dynamic range.

Adjusting the DSP effect

Adjusting DSP (Digital Signal Processor) effects.

You can make adjustments for each DAP mode and save them in memory.

1. Open the SOUND MENU.

See page 41, "Opening the SOUND MENU".

2. Move the pointer to DSP EFFECT using the ▲/▼ cursors.

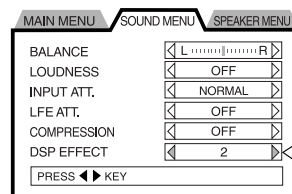

3. Use the ◀▶ cursors to adjust the DSP effect.

Choose a DSP effect level between 1 ~ 5.

- The pointer cannot be adjusted to the DSP effect when "- -" appears.

SPEAKER MENU Settings

Use the primary remote control to perform speaker settings with the on-screen SPEAKER MENU.

Buttons used

MAIN ON SCREEN, the ◀/▶/▲/▼ cursors, and ENTER.

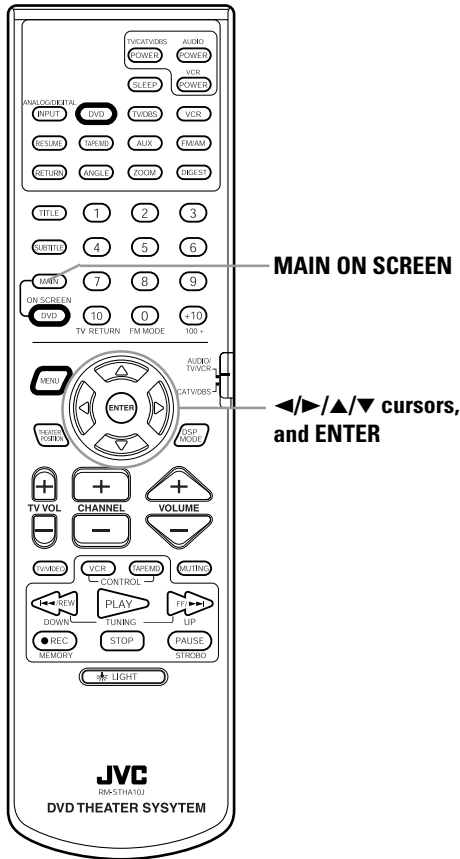

Before performing speaker settings

There are two speaker modes, STANDARD and EXPERT.

STANDARD : This is the default setting for using the speakers that come with this system.

EXPERT : Use expert settings when speaker placement prevents full 3-dimensional surround sound, or when using speakers other than those that came with the system.

When the speaker mode is set to STANDARD, only the speaker mode may be changed. Other options (shown in gray) cannot be selected.

Setting the speaker mode to EXPERT enables additional speaker setting options. (The enabled options will be highlighted)

Speaker mode

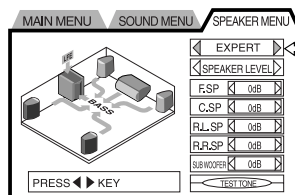
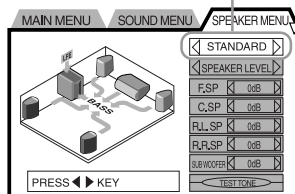

Opening the SPEAKER MENU

- 1. Stop DVD image playback on the TV screen.**
Select a playback source other than the tuner. If the playback source is set to DVD, press STOP to quit playback.
- 2. Press MAIN ON SCREEN.**
The MAIN MENU will be displayed.
- 3. Move the pointer to the SPEAKER MENU tag using the ◀/▶ cursors.**
- 4. When you are finished with on-screen settings, press MAIN ON SCREEN again to close the SPEAKER MENU.**

Switching speaker mode

- 1. Open the SPEAKER MENU.**
See "Opening the SPEAKER MENU".
- 2. Move the pointer to STANDARD using the ▲/▼ cursors.**

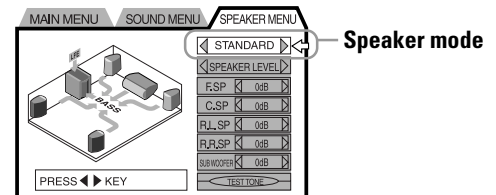

- 3. Use the ◀/▶ cursors to switch between STANDARD and EXPERT.**
Enabled options will be highlighted.

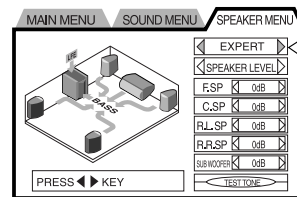

Playing a test tone

When you wish to play a test tone, make sure the sound mode is set to “SURROUND ON” or “THEATER.” The test tone will not play in other modes.

- 1. Open the SPEAKER MENU.**
See page 43, “Opening the SPEAKER MENU”.
- 2. Switch the speaker mode to EXPERT.**
- 3. Move the pointer to TEST TONE using the ▲/▼ cursors.**
- 4. Press ENTER.**

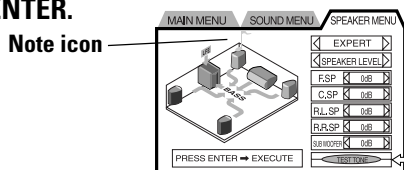

Test tones will be played in the following order:

Left Front Speaker → Center Speaker → Right Front Speaker
 ↑ ↓
 Left Rear Speaker ← Right Rear Speaker

- The note icon on the screen moves to the active speaker. On the center unit, the audio channel display lamp also moves to the active speaker, and the name of the active speaker appears in the display window, reflecting the configuration of the audio channel display lamps.
- The test tone is 6.

To stop the test tone, move the pointer to TEST TONE and press ENTER.

Note:

- The test tone stops when the pointer moves from TEST TONE while the speaker selection box displays “SPEAKER SIZE” or “DELAY”.
- Settings may be entered while the tone is sounded only if the speaker selection box displays “SPEAKER LEVEL”.

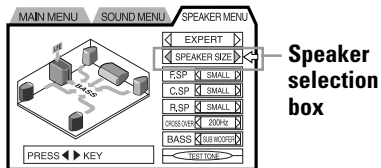

Setting speaker size

- 1. Open the SPEAKER MENU.**
See page 43, “Opening the SPEAKER MENU”.
- 2. Switch the speaker mode to EXPERT.**
- 3. Move the pointer to the speaker selection box using the ▲/▼ cursors.**

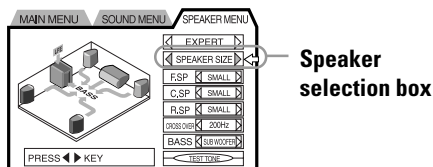

- 4. Use the ◀/▶ cursors to select SPEAKER SIZE.**

Pressing the ◀/▶ cursors toggles between the following settings.

↔SPEAKER SIZE↔SPEAKER LEVEL↔DELAY↔

- 5. Set speaker size.**

Use the ▲/▼ cursors to move to the parameter you wish to set, then adjust the parameter with the ◀/▶ cursors.

The Note icon on the screen indicates the selected speaker.

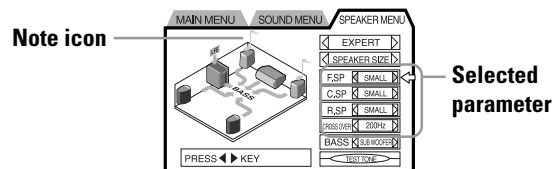

Speaker parameters

Speaker size

Select LARGE when the cone speaker imbedded in the speaker being used has a diameter of 12 cm or more.

Select SMALL when the diameter is less than 12 cm.

When using this system’s front, center, or rear speakers select SMALL for each.

Selecting LARGE may result in speaker damage.

F. SP : Sets left and right front speaker size.
 Pressing the ◀/▶ cursors toggles between the following settings.

SMALL ↔ LARGE

C. SP : Sets center speaker size.
 Pressing the ◀/▶ cursors toggles between the following settings.

When the F.SP is selected “SMALL”:
SMALL ↔ OFF

When the F.SP is selected “LARGE”:
↔ SMALL ↔ LARGE ↔ OFF ↔

- Select OFF when the center speaker is not connected, or is not in use.

R. SP : Sets rear speaker size.
 Pressing the ◀/▶ cursors toggles between the following settings.

When the F.SP is selected “SMALL”:
SMALL ↔ OFF

When the F.SP is selected “LARGE”:
↔ SMALL ↔ LARGE ↔ OFF ↔

- Select OFF when the rear speaker is not connected, or is not in use.

CROSS OVER : When using a small speaker with weak bass as a front, center, or rear speaker, you can redirect bass audio to the sub-woofer. Select a cross over frequency to match the size of the small speaker being used.

Pressing the ◀/▶ cursors toggles between the following settings.

200Hz ↔ 100Hz ↔ 120Hz

Cross over frequency	Speaker diameter
100Hz	approx. 10 cm (4")
120Hz	approx. 8 cm (3-3/16")
200Hz	approx. 4 cm (1-5/8")

BASS : BASS is fixed for SUBWOOFER. This cannot be selected with the pointer.

Setting speaker level

- 1. Open the SPEAKER MENU.**
See page 43, "Opening the SPEAKER MENU".
- 2. Switch the speaker mode to EXPERT.**
- 3. Move the pointer to the speaker selection box using the ▲/▼ cursors. Use the ◀/▶ cursors to select SPEAKER LEVEL.**
Pressing the ◀/▶ cursors switches between the following settings.

◀SPEAKER SIZE ↔ SPEAKER LEVEL ↔ DELAY ▶

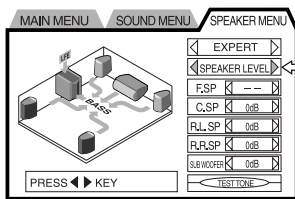

- 4. Play a test tone (only when the DSP mode is set to "SURROUND ON" or "THEATER").**
Using the ▲/▼ cursors, move the pointer to TEST TONE and press ENTER.

Note:

- The speaker level can be set without playing a test tone.
- Speakers with speaker size set to OFF will not play a test tone.

- 5. Adjust speaker level.**
Use the ▲/▼ cursors to move the pointer to the parameter you wish to set. Then adjust the level using the ◀/▶ cursors. The Note icon on the screen indicates the selected speaker.

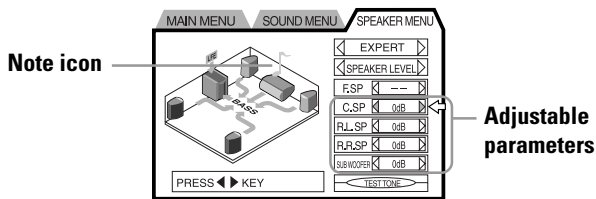

- C.SP** : Adjust center speaker level.
R.L.SP : Adjust left rear speaker level.
R.R.SP : Adjust right rear speaker level.
SUB WOOFER : Adjust sub-woofer level.

- Each speaker level can be adjusted from -10 dB to +10 dB.
- Speakers marked with a " --- " cannot be adjusted.
- The F.SP (Front Speaker) level cannot be adjusted.
- You can save center speaker and rear speaker adjustments for each DSP mode and save them in memory.

After adjusting speaker levels

- 6. Stop test tone playback.**
Use the ▲/▼ cursors to move the pointer to TEST TONE and press ENTER.

Adjusting delay time

The delay time for the center speaker and rear speakers is calculated by comparing the distance between the rear/center speakers and the listening point with the distance between the front speakers and the listening point.

- 1. Open the SPEAKER MENU.**
See page 43, "Opening the SPEAKER MENU".
- 2. Switch the speaker mode to EXPERT.**
- 3. Move the pointer to the speaker selection box using the ▲/▼ cursors. Use the ◀/▶ cursors to select DELAY.**
Pressing the ◀/▶ cursors switches between the following settings.

◀SPEAKER SIZE ↔ SPEAKER LEVEL ↔ DELAY ▶

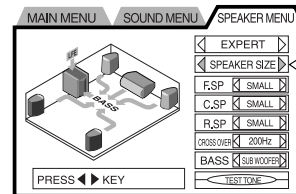

- 4. Adjusting delay time.**
Use the ▲/▼ cursors to move the pointer to the parameter you wish to set. Then adjust the delay time using the ◀/▶ cursors. The Note icon on the screen indicates the selected speaker.

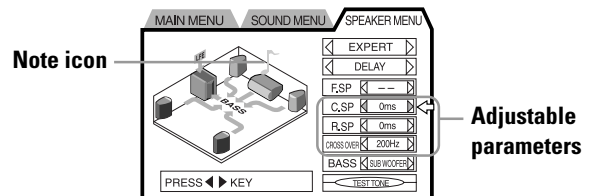

- C.SP** : Adjusts the center speaker delay time. Delay time can be set between 0 ms and 5 ms. When the distance between the listening point and the center speaker is close to the distance to the front speakers, set the delay time to 0 ms. Increase the delay time when the distance to the center speaker is shorter.
- A 1ms increase/decrease of delay time is equivalent to a 30 cm change in distance.
- R.SP** : Adjusts the rear speaker delay time. Delay time can be set between 0 ms and 15 ms. When the distance between the listening point and the rear speakers is close to the distance to the front speakers, set the delay time to 0ms. Increase the delay time when the distance to the rear speakers is shorter.
- A 1ms increase/decrease of delay time is equivalent to a 30 cm change in distance.

- Speakers marked with a " --- " cannot be adjusted.
- "CROSS OVER" has the same effect as setting with "SPEAKER SIZE".

DVD MENU Settings

Use the primary or secondary remote control to perform DVD settings with the on-screen DVD MENU.

Buttons used

DVD ON SCREEN, and the ◀/▶/▲/▼ cursors.

Primary remote control

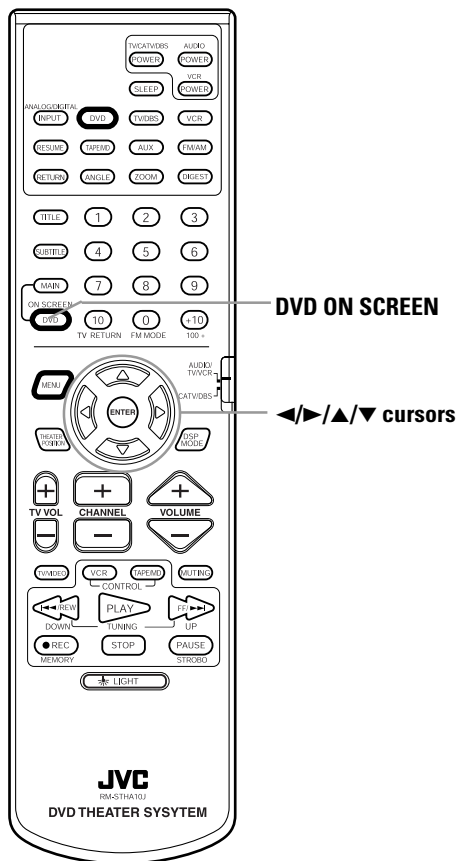

Secondary remote control

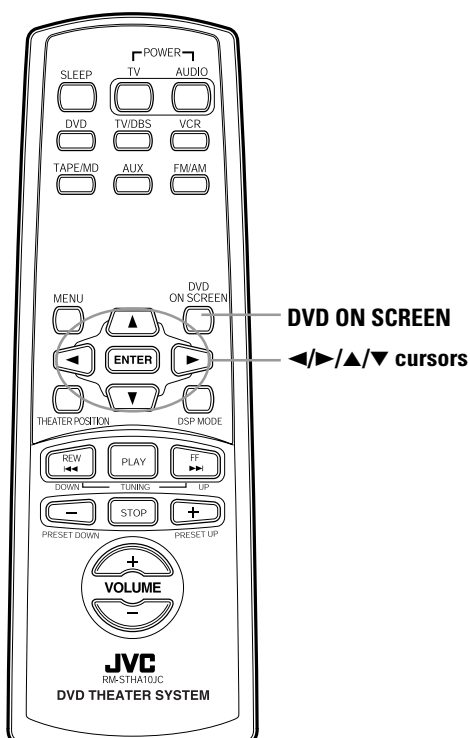

Opening the DVD MENU

1. Change source to DVD, and stop playback.

When a Video CD or Audio CD is inserted, press ▲ on the center unit to open the disc tray.

2. Press DVD ON SCREEN.

The DVD MENU will be displayed.

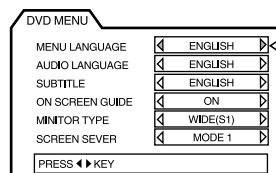

3. When you are finished with on-screen settings, press DVD ON SCREEN to close the DVD MENU.

Choosing menu language

Some DVD discs feature menu display in multiple languages. With these discs, it is possible to set the default language for menu display.

1. Open the DVD MENU.

See "Opening the DVD MENU".

2. Move the pointer to MENU LANGUAGE using the ▲/▼ cursors.

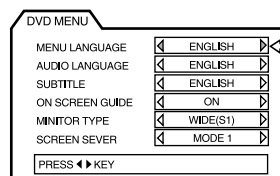

3. Use the ◀/▶ cursors to select a default menu language.

Pressing the cursors toggles between the following options.

→ ENGLISH → SPANISH → FRENCH → CHINESE → GERMAN → ITALIA → JAPANESE → language code (AA ~ ZU) →

(back to the beginning)

(See "Appendix A: Table of languages and their abbreviations".)

Note:

- When the selected language is not available on the disc, display will switch to an available language.

Choosing audio language

Some DVD discs feature audio playback in multiple languages. With these discs, it is possible to set the default language for audio playback.

1. Open the DVD MENU.

See page 46, "Opening the DVD MENU".

2. Move the pointer to AUDIO LANGUAGE using the ▲/▼ cursors.

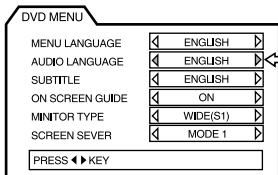

3. Use the ◀/▶ cursors to select a default audio language.

Pressing the cursors toggles between the following options.

→ ENGLISH → SPANISH → FRENCH → CHINESE → GERMAN
→ ITALIA → JAPANESE → language code (AA ~ ZU) →

(back to the beginning)

(See "Appendix A: Table of languages and their abbreviations".)

Note:

- When the selected language is not available on the disc, audio playback will switch to an available language.

Choosing subtitle language

Some DVD discs feature subtitle display in multiple languages. With these discs, it is possible to set the default language for subtitle display.

1. Open the DVD MENU.

See page 46, "Opening the DVD MENU".

2. Move the pointer to SUBTITLE using the ▲/▼ cursors.

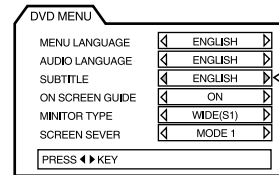

3. Use the ◀/▶ cursors to select a default subtitle display language.

Pressing the cursors toggles between the following options.

→ ENGLISH → SPANISH → FRENCH → CHINESE → GERMAN
→ ITALIA → JAPANESE → language code (AA ~ ZU) →

(back to the beginning)

(See "Appendix A: Table of languages and their abbreviations".)

Note:

- When the selected language is not available on the disc, subtitle display will switch to an available language.

On-screen guide settings

During DVD playback, an on-screen guide displaying symbols or letters over the DVD image can be set ON or OFF.

1. Open the DVD MENU.

See page 46, "Opening the DVD MENU".

2. Move the pointer to ON SCREEN GUIDE using the ▲/▼ cursors.

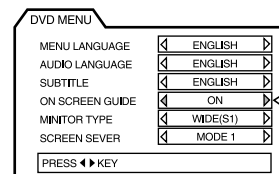

3. Use the ◀/▶ cursors to select ON or OFF.

Pressing the cursors toggles between ON and OFF.

ON : Icons and letters are displayed.

OFF : Icons and letters are not displayed.

Select monitor type

Most movie DVD discs are recorded for wide-screen TVs with a height/width ratio of 16:9. It is possible to optimize playback of these wide-screen TV images for viewing on a regular TV with a height/width ratio of 4:3.

1. Open the DVD MENU.

See page 46, "Opening the DVD MENU".

2. Move the pointer to MONITOR TYPE using the ▲/▼ cursors.

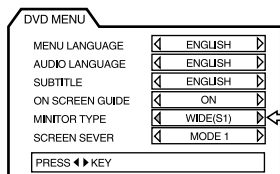

3. Use the ◀/▶ cursors to select monitor type.

Pressing the cursors toggles between the following monitor configurations.

4:3 LB (Letter Box Conversion):



Select this option for playback on a TV with a height/width ratio of 4:3. The image will be displayed with a black bar at the top and bottom of the screen. The left and right edges of the image are preserved.

4:3 PS (Pan-scan Conversion):

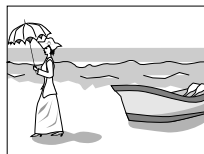

Select this option for playback on a TV with a height/width ratio of 4:3. The image will be displayed with the right and left edges cropped. No black gap will appear at the top and bottom of the screen.

WIDE (S1) (Wide Television Screen 16 : 9):



Select this option for playback on a wide-screen TV.

Note:

- If the DVD disc is not optimized for Pan-scan, the image will be shown in 4:3 LB (Letter Box Conversion), even if 4:3 PS (Pan-scan Conversion) is selected.

Screen saver settings

Set the screen saver to prevent screen burn.

1. Open the DVD MENU.

See page 46, "Opening the DVD MENU".

2. Move the pointer to SCREEN SAVER using the ▲/▼ cursors.

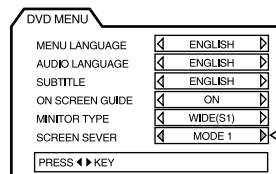

3. Use the ◀/▶ cursors to select a screen saver mode.

Pressing the cursors toggles between the following screen saver modes: MODE 1, MODE 2, DIMMER, and OFF.

MODE 1 : The "screen saver" picture appears and scrolls.

MODE 2 : The "screen saver" picture appears and does not scroll.

DIMMER : The current picture gets dark.

OFF : The screen saver function is off.

Notes:

- Select a different mode if the screen flickers when the screen saver is set to MODE 1.
- When DIMMER is selected, in addition to the screen saver function, the display window will also be dimmed. To prevent this, change to a different mode.
- Please be wary of screen burn when the screen saver is turned OFF.

Limiting playback by children

This function restricts playback of DVD discs which contain violent (and other) scenes according to the level set by the user. For example, if a movie which includes violent scenes supports the parental lock feature, such scenes which you do not want to let children view can be cut or replaced with other scenes.

To set Parental Lock for the first time [PARENTAL LOCK]

■ While a DVD disc is stopped or no disc is inserted

From primary remote control:

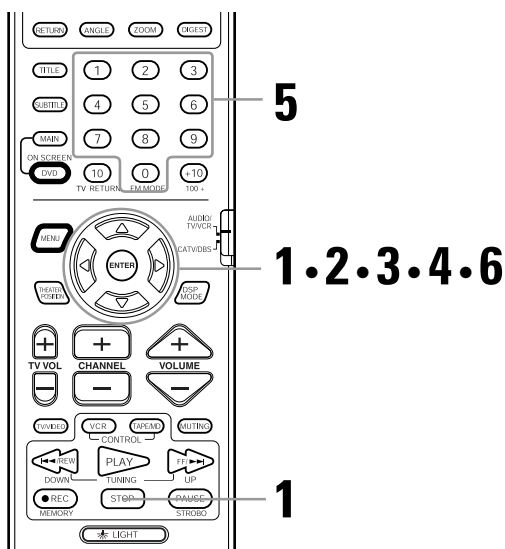

- 1. Press ENTER while holding down STOP.**
The PARENTAL LOCK onscreen display appears on the TV screen.
- 2. Use CURSOR ▲/▼ to move the pointer to "Country Code", then use CURSOR ◀/▶ to select "US" for country code and press ENTER.**

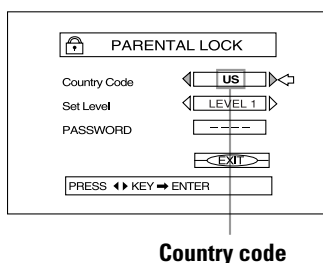

- 3. Use CURSOR ▲/▼ to move the pointer to "Set Level", then use CURSOR ◀/▶ to select the parental lock level.**

Each time you press CURSOR ▶, the parental level changes as follows:

→ "LEVEL 1" ~ "LEVEL 8" → "--" (No restriction) → (back to the beginning)

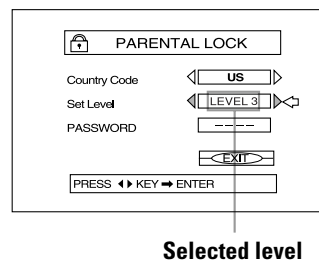

- "LEVEL 1" is the strictest level.
Discs rated higher than the level you selected are restricted.

- 4. Press ENTER.**
- 5. Enter your 4-digit password using the number buttons (0 ~ 9).**

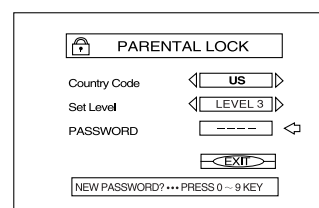

- 6. Press ENTER.**
The parental level and password are set.
The pointer moves to "EXIT".

To turn off the PARENTAL LOCK onscreen display
Press ENTER again.

To change the settings

- While a DVD disc is stopped or no disc is inserted

1. Press ENTER while holding down STOP.

The Parental Lock on-screen display appears on the TV screen.

2. Enter your current 4-digit password using the number buttons (0 to 9) and press ENTER.

If you enter the wrong password, "WRONG! RETRY....." appears on the TV screen, and you cannot go to next step.

3. Use CURSOR ▲/▼ to move the pointer to "Set Level", then use CURSOR ◀/▶ to select the parental lock level.

4. Press ENTER.

5. Enter your new 4-digit password using the number buttons (0 to 9) and press ENTER.

The new setting is effective.

Notes:

- When you enter the wrong password more than 3 times in step 2 above, the pointer moves to "EXIT" automatically and CURSOR ▲/▼ does not work.
- If you forget your password in step 2 Enter "8888."

To temporarily release the Parental lock

When you set the parental level strictly, some discs may not be played back at all. When you insert such a disc and try to play it, the Parental Lock on-screen display appears on the TV screen, and the unit will ask you whether you want the parental lock to be temporarily released or not.

1. Use the CURSOR ▲/▼ to move the pointer to "Temporary", then use CURSOR ◀/▶ to select YES or NO, then press ENTER.

If you select YES, the pointer moves to the PASSWORD field. When selecting NO, press ▲ to remove the disc.

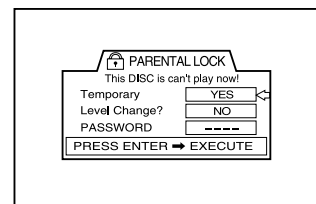

2. Enter your 4-digit password using the number buttons (0 to 9).

If you enter the wrong password, "WRONG! RETRY..." appears on the TV screen, and you cannot go to next step.

- The Parental lock is released, and the unit starts playback.

Note:

- When you enter the wrong password more than 3 times in step 2 above, moves to "NO" automatically and CURSOR ▲/▼ does not work.

Care and handling of discs

How to handle discs

When handling a disc, do not touch the surface of the disc. Since discs are made of plastic, they are easily damaged. If a disc gets dirty, dusty, scratched or warped, the images and sound will not be picked up correctly, and such a disc may cause the player to malfunction.

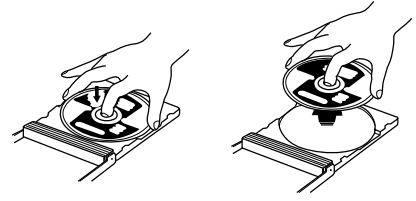

Label side

Do not damage the label side, stick paper to or use any adhesive on its surface.

Storage

Make sure that discs are kept in their cases. If discs are piled on top of one another without their protective cases, they can be damaged. Do not put discs in a location where they may be exposed to direct sunlight, or in a place where the humidity or temperature is high. Avoid leaving discs in your car!

Maintenance of discs

If there are fingerprints or other dirt adhering to a disc, wipe with a soft dry cloth, moving from the center outwards.

If a disc is difficult to clean, wipe with a cloth moistened with water. Never use record cleaners, petrol, alcohol or any anti-static agents.

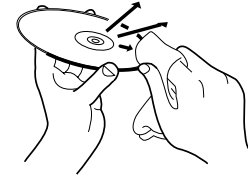

CAUTION:

Sometimes during play noise or images may be garbled. This is sometimes due to the disc. (It may not be up to industry standards.) These symptoms are caused by the discs, not by the malfunction of the center unit.

AV COMPU LINK Remote Control System

The AV COMPU LINK remote control system allows you to operate JVC video components (TV and VCR) through the center unit.

To use this remote control system, you need to connect the video components you want to operate, follow the diagrams below and the procedure on the next page.

CONNECTIONS 1

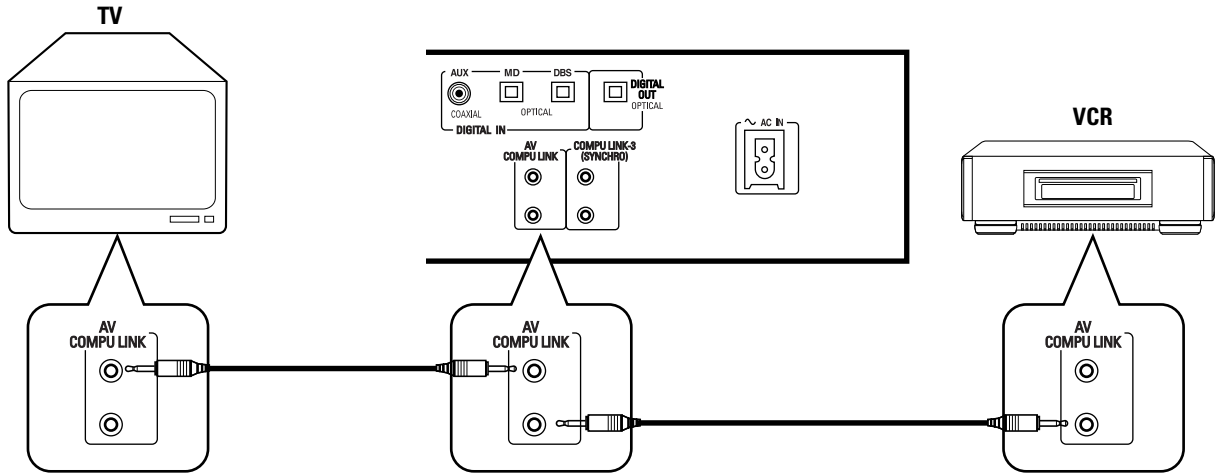

CAUTION:

The AV COMPU LINK remote control system cannot control the DBS tuner connected to the TV SOUND/DBS jacks on the center unit.

Notes:

- Refer also to the manual supplied with your video components.

CONNECTIONS 2

CASE 1: If the components are equipped with the S-video terminals.

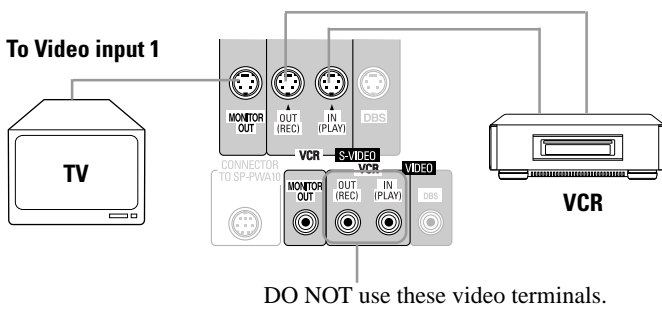

CASE 2: If the components are not equipped with the S-video terminals.

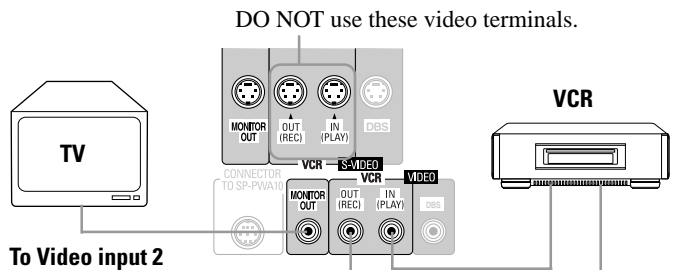

CASE 3: If only the VCR is equipped with the S-video terminal.

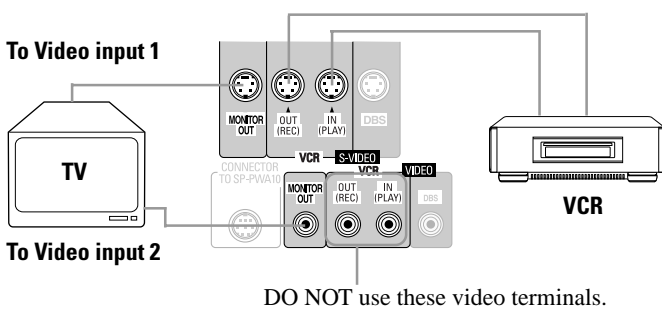

CASE 4: If only the VCR is not equipped with the S-video terminal.

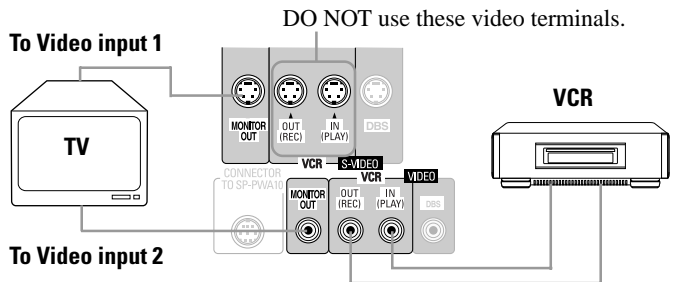

- 1. If you have already plugged your VCR, TV, and center unit into the AC outlets, unplug their AC power cords first.**
- 2. Connect your VCR, TV, and center unit as follows, using the cables with the monaural mini-plugs.**
 - See “CONNECTIONS 1” on the previous page.
- 3. Connect the audio input/output jacks on VCR, TV, and center unit using the cables with RCA pin plug**
 - See pages 8 and 9.
- 4. Connect the video input/output jacks on VCR, TV, and center unit, using the cables with RCA pin plug or with S-video plug.**
 - See “CONNECTIONS 2” on the previous page.
- 5. Plug the AC power cords of the components into the AC outlets.**
- 6. When turning on the TV for the first time after the AV COMPU LINK connection, turn the TV volume to the minimum using the TV volume control on the TV.**

The AV COMPU LINK remote control system allows you to use the four basic functions listed below.

Remote control of the TV and VCR using this remote control

See page 55 for details.

For the VCR and the TV:

- Aim the remote control directly at the remote sensor on each component.

One-Touch Video Play

Simply by inserting a video cassette without its safety tab into the VCR, you can enjoy the video playback without setting other switches manually. The center unit automatically turns on and changes the source to “VCR.”

The TV automatically turns on and changes the input mode to the position so that you can view the playback picture.

When you insert a video cassette with its safety tab, press the play (▶) button on the VCR or on the remote control. So, you can get the same result.

Automatic Selection of TV's Input Mode

- When you select “TV SOUND” as the source to play on the center unit, the TV automatically changes the input mode to the TV tuner so that you can watch TV.
- When you select “VCR” or “DBS” (or “DBS DIGITAL”) as the source to play on the center unit, the TV automatically changes the input mode to the appropriate position (either Video Input 1 or Video Input 2) so that you can view the playback picture.

Note:

- When you select “TV SOUND” as the source on the center unit, you cannot see the menu on the TV screen since the AV COMPU LINK remote control system automatically changes the TV's input mode to the TV tuner.

If you do not mind stopping listening to the TV sounds, you can then show the on-screen displays after changing the TV's input mode to the appropriate position (either Video Input 1 or Video Input 2) the center unit is connected to.

Automatic Power On/Off

The TV and VCR turn on and off along with the center unit.

When you turn on the center unit;

- If the previously selected source is “DVD” the TV will turn on automatically.
- If the previously selected source is “VCR” the TV and VCR will turn on automatically.
- If the previously selected source is “TV SOUND” or “DBS” (or “DBS DIGITAL”), only the TV will turn on automatically.

When you turn off the center unit, the TV and VCR will turn off.

Notes:

• When system power is ON:

- If the television monitor power is OFF, starting DVD playback will not turn on the television monitor. Additionally, if the playback source is other than DVD, playing a DVD will not automatically switch the television monitor to video input. Please perform the necessary operations directly with the television monitor.
- If you turn off the center unit while recording on the VCR, the VCR will not turn off, but continue recording.
- When “TV SOUND” is selected, in order for the AV COMPU LINK to change television input to “TV,” the onscreen display will not be viewable on the television monitor. To view the onscreen display, set the television monitor to the correct video input.
- When connected to a television with a DBS tuner, the television's automatic DBS switch will not operate.

COMPU LINK Remote Control System

The COMPU LINK remote control system allows you to operate JVC audio components through the remote sensor on the center unit.

To use this remote control system, you need to connect JVC audio components through the COMPU LINK-3 (SYNCHRO) jacks (see below) in addition to the connections using cables with RCA pin plugs (see pages 8 and 9).

- **Make sure that the AC power cords of these components are unplugged before connection. Plug the AC power cords only after all connections are complete.**

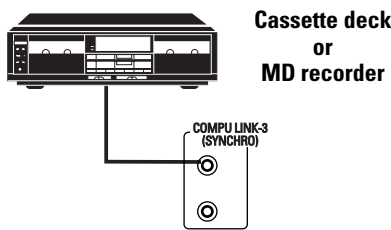

Notes:

- If your audio component has two COMPU LINK-3 (SYNCHRO) jacks, you can use either one.
- To operate the cassette deck or MD recorder using the COMPU LINK remote control system, set the source name correctly.(see page 17).
- Refer also to the manuals supplied with your audio components. This remote control system allows you to use three functions listed right.
- Synchro recording for the cassette deck or MD recorder using the COMPU LINK remote control system is not compatible with the center unit.

Remote Control through the Remote Sensor on the center unit

You can control the connected audio components through the remote sensor on the center unit using this remote control. Aim the remote control directly at the remote sensor on the center unit. For details, see page 10.

Automatic Source Selection

When you press the play (▶) button on a connected component or on its own remote control, the center unit automatically turns on and changes the source to the component. On the other hand, if you select a new source on the center unit or on the remote control, the selected component begins playing immediately.

In both cases, the previously selected source continues playing without sound for a few seconds.

Automatic Power On/Off (Standby): only possible with the COMPU LINK-3 connection

Cassette deck (or MD recorder) turns on and off (standby) along with the center unit.

When you turn on the center unit, the cassette deck (or MD recorder) will turn on automatically, depending on which component has been previously selected.

When you turn off the center unit, the cassette deck (or MD recorder) will turn off (standby).

Operating JVC's Audio/Video Components

You can operate JVC's audio and video components with this system's remote control, since control signals for JVC components are preset in the remote control.

IMPORTANT:

To operate JVC's audio components using this remote control:

- You need to connect JVC audio components through the COMPU LINK-3 (SYNCHRO) jacks (see page 54) in addition to the connections using cables with RCA pin plugs (see pages 8 and 9).
- Aim the remote control directly at the remote sensor on the center unit.
- If you use the buttons on the front panel or the menu function to choose a source, the remote control will not operate that source. To operate a source with the remote control, the source must be selected using source selecting buttons on the remote control.
- To operate the cassette deck or MD recorder using the COMPU LINK remote control system, set the source name correctly (see page 17).
- Refer also to the manuals supplied with your components.

To operate JVC's video components using this remote control:

- You need to connect JVC video components through the AV COMPU LINK terminals (see page 52) in addition to the connections using cables with RCA pin plugs (see pages 8 and 9).
- Some JVC VCRs can accept two types of the control signals — remote code "A" and "B." Before using this remote control, make sure that the remote control code of the VCR is set to code "A."
- When using the remote control:
 - Aim the remote control directly at the remote sensor on each component, not on the center unit.

Primary remote control

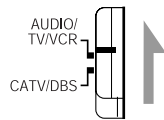
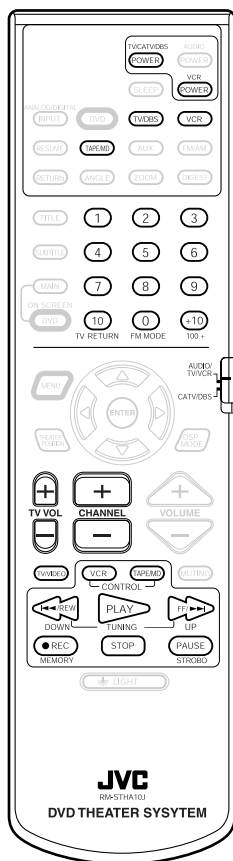

Check to see if its remote control mode selector is set to the correct position.

To operate the audio system, TVs, and VCRs, set it to "AUDIO/TV/VCR."

Primary remote control

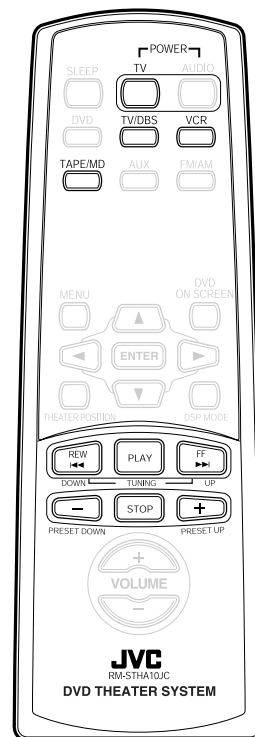

Cassette deck

After pressing TAPE/MD or TAPE/MD CONTROL (with the remote control mode selector set to "AUDIO/TV/VCR"), you can perform the following operations on a cassette deck:

- PLAY** : Starts playing.
- ◀◀** : Fast winds the tape from right to left.
- ▶▶** : Fast winds the tape from left to right.
- STOP** : Stops operations.
- PAUSE** : Pauses playing. To release it, press PLAY.
- **REC** : Press this button with the PLAY button to start recording.
Press this button with the PAUSE button to enter recording pause.

MD recorder

After pressing TAPE/MD or TAPE/MD CONTROL (with the remote control mode selector set to "AUDIO/TV/VCR"), you can perform the following operations on the MD recorder:

- PLAY** : Starts playing.
- ◀◀** : Returns to the beginning of the current (or previous) track.
- ▶▶** : Skips to the beginning of the next track.
- STOP** : Stops playing.
- PAUSE** : Pauses playing. To release it, press PLAY.
- **REC** : Press this button with the PAUSE to enter recording pause. Then press PLAY to start recording.

After pressing TAPE/MD:

- 1 ~ 9, 0** : Selects the track.

Note:

- You can use either TAPE/MD button or the TAPE/MD CONTROL button to activate the buttons listed above. If you press TAPE/MD, the playing source also changes. On the other hand, if you press TAPE/MD CONTROL, the playing source does not change.

VCR

You can always perform the following operations (with the remote control mode selector set to "AUDIO/TV/VCR"): **VCR POWER**: Turns on or off the VCR.

After pressing VCR or VCR CONTROL (with the remote control mode selector set to "AUDIO/TV/VCR"), you can perform the following operations on the VCR:

- PLAY** : Starts playing.
- ◀◀** : Rewinds a tape.
- ▶▶** : Fast winds a tape.
- STOP** : Stops operations.
- PAUSE** : Pauses playing. To release it, press PLAY.
- **REC** : Press this button with the PLAY button to start recording.
Press this button with the PAUSE button to enter recording pause.

After pressing VCR:

- 1 ~ 9, 0** : Selects the TV channels on VCR.
- CHANNEL +/-** : Changes the TV channels on the VCR.

Note:

- You can use either VCR button or the VCR CONTROL button to activate the buttons listed above. If you press VCR, the playing source also changes. On the other hand, if you press VCR CONTROL, the playing source does not change.

TV

You can always perform the following operations (with the remote control mode selector set to "AUDIO/TV/VCR"):

- TV/CATV/DBS POWER** : Turns on or off the TV.
- TV VOL +/-** : Adjusts the volume.
- TV/VIDEO** : Sets the input mode (either TV or VIDEO).
After pressing TV/DBS (with the remote control mode selector set to "AUDIO/TV/VCR"), you can perform the following operations on a TV:
 - CHANNEL +/-** : Changes the channels.
 - 1 - 9, 0, 100+** : Selects the channels.
 - TV RETURN** : Alternates between the previously selected channel and the current channel.

Operating Other Manufacturers' Video Equipment

This remote control supplied with the receiver can transmit control signals for other manufacturers' VCRs, TVs, CATV converters and DBS tuners. By changing the transmittable signals from preset ones to the other manufacturers', you can operate the other manufacturer's components using this remote control.

When operating the other manufacturers' components, refer also to the manuals supplied with them. To operate these components with the remote control, first you need to set the manufacturer's code each for VCR, TV, CATV converters, and DBS tuner.

Primary remote control

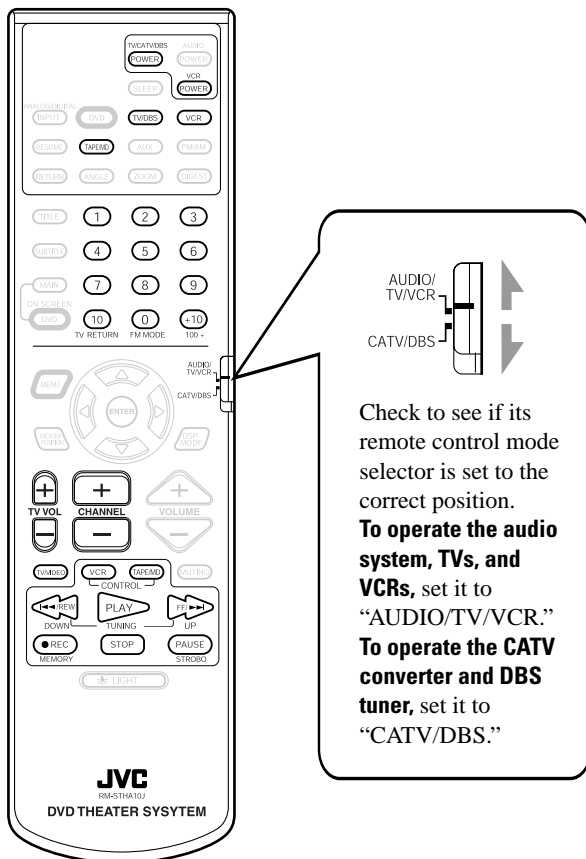

To change the transmittable signals for operating another manufacturer's TV

1. Set the remote control mode to "AUDIO/TV/VCR."
2. Press and hold TV/CATV/DBS POWER.
3. Press TV/DBS.
4. Enter manufacturer's code (three digits) using buttons 1 – 9, and 0.

See the list on pages 59 and 60 to find the code.

Examples: For a JVC product, press 0, 5, then 3.

For a Hitachi product, press 0, 5, then 6.

5. Release TV/CATV/DBS POWER.

The following buttons can be used for operating the TV (with the remote control mode selector set to "AUDIO/TV/VCR"):

TV/CATV/DBS POWER : Turns on and off the TV.

TV VOL +/- : Adjusts the volume.

TV/VIDEO : Sets the input mode (either TV or VIDEO).

After pressing TV/DBS (with the remote control mode selector set to "AUDIO/TV/VCR"), you can perform the following operations on a TV:

CHANNEL +/- : Changes the channels.

1 – 10, 0, 100+ (+10) : Selects the channels.

100+ (+10) button will function as the ENTER button if your TV requires pressing ENTER after selecting a channel number.

Note:

- Refer to the manual supplied with your TV.

6. Try to operate your TV by pressing TV/CATV/DBS POWER.

When your TV turns on or off, you have entered the correct code.

If there are more than one code listed for your brand of TV, try each one until the correct one is entered.

Manufacturer	Code	Manufacturer	Code
JVC	01	SAMSUNG	12
HITACHI	10	SANYO	13
MAGNAVOX	02	SHARP	06
MITSUBISHI	03	SONY	07
PANASONIC	04, 11	TOSHIBA	08
RCA	05	ZENITH	09

Manufactures' codes are subject to change without notice. If they are changed, this remote control cannot operate the equipment.

To change the transmittable signals for operating a CATV converter or DBS tuner _____

- 1. Set the remote control mode to "CATV/DBS."**
- 2. Press and hold TV/CATV/DBS POWER.**
- 3. Press TV/DBS.**
- 4. Enter manufacturer's code (three digits) using buttons 1–9, and 0.**
- 5. Release TV/CATV/DBS POWER.**

See the list on page 60 to find the code.

Examples: For a JVC product, press 7, 7, then 5.
For a Pioneer product, press 1, 4, then 4.

TV/CATV/DBS POWER: Turns on and off the CATV converter or DBS tuner.

CHANNEL +/- : Changes the channels.

1 – 10, 0, 100+ (+10) : Selects the channel.
100+ (+10) button will function as the ENTER button if your equipment requires pressing ENTER after selecting a channel number.

Note:

- Refer to the manual supplied with your CATV converter or DBS tuner.

6. Try to operate your CATV converter or DBS tuner by pressing TV/CATV/DBS POWER.

When your CATV converter or DBS tuner turns on or off, you have entered the correct code.

If there are more than one code listed for your brand of CATV converter or DBS tuner, try each one until the correct one is entered.

Manufacturer	Code
ECHOSTAR	21
GI JERROLD	01, 02, 03, 04, 05, 06, 07, 08
HAMLIN/REGAL	15, 16, 17, 18
PIONEER	13, 14
RCA	19
SCIENTIFIC ATLANTA	09, 10
SONY	20
ZENITH	11, 12

Manufacturers' codes are subject to change without notice. If they are changed, this remote control cannot operate the equipment.

To change the transmittable signals for operating another manufacturer's VCR _____

- 1. Set the remote control mode to "AUDIO/TV/VCR."**
- 2. Press and hold VCR POWER.**
- 3. Press VCR.**
- 4. Enter manufacturer's code (three digits) using buttons 1–9, and 0.**
- 5. Release VCR POWER.**

See the list on pages 61 and 62 to find the code.

Examples: For a JVC product, press 0, 0, then 8.
For a Funai product, press 0, 0, then 0.

VCR POWER : Turns on and off the VCR.

After pressing VCR or VCR CONTROL (with the remote control mode selector set to "AUDIO/TV/VCR"), you can perform the following operations on the VCR:

- PLAY :** Starts playback.
- ◀◀ :** Rewinds a video tape.
- ▶▶ :** Fast winds a video tape.
- STOP :** Stops operation.
- PAUSE :** Pauses.
- REC :** Starts recording or enters recording pause.

After pressing VCR:

CHANNEL +/- : Changes the TV channels on the VCR.

1 – 10, 0, 100+ (+10) : Selects the TV channels.
100+ (+10) button will function as the ENTER button if your VCR requires pressing ENTER after selecting a channel number.

Notes:

- Refer to the manual supplied with your VCR.
- You can use either VCR button or the VCR CONTROL button to activate the buttons listed above. If you press VCR, the playing source also changes. On the other hand, if you press VCR CONTROL, the playing source does not change.

6. Try to operate your VCR by pressing VCR POWER.

When your VCR turns on or off, you have entered the correct code.

If there are more than one code listed for your brand of VCR, try each one until the correct one is entered.

Manufacturer	Code	Manufacturer	Code
JVC	01, 02, 03	PHILIPS	09
EMERSON	11, 26	RCA	05, 06
FISHER	29	SAMSUNG	24
FUNAI	10, 14, 15, 16	SANYO	21, 22, 23
GOLD STAR	12	SHARP	27, 28
HITACHI	04	SHINTOM	30
MITSUBISHI	13	SONY	18, 19, 20
NEC	25	ZENITH	08
PANASONIC	07, 17		

Manufacturers' codes are subject to change without notice. If they are changed, this remote control cannot operate the equipment.

Troubleshooting

Use this chart to help you solve daily operational problems. If there is any problem you cannot solve, contact your JVC service center.

PROBLEM	POSSIBLE CAUSE	SOLUTION
Power does not come on.	The power cord.	Insert the plug into the socket.
Power is not supplied to the powered sub-woofer	The power cord has been pulled out of the AC outlet. The system cable is not connected.	Press the power button on the center unit to switch power OFF, and then press it again to switch power ON.
The remote control does not work.	It is too far from the center unit, or is not facing the center unit. There is something obstructing the remote sensor.	Avoid any obstacles within approximately 5 m of the detector on the remote control.
	The battery is flat.	Replace the battery.
	The battery has been inserted the wrong way round (+/-).	Insert the battery correctly.
	Sunlight is falling directly on the detector.	Shade the remote control from direct sunlight.
	The entered manufacturers code number is incorrect.	Enter the correct code number.
No sound.	The system cable is not connected.	Check the connection.
	The speaker cord is not connected.	Check the connection.
	There is a short in the speaker cord.	Reconnect the speaker cord and press POWER on the center unit to restart the system.
	The powered sub-woofer power supply is off.	Insert the plug firmly into the socket and press POWER on the center unit to switch power off, and then press it again to switch power on.
	The audio cord is not connected properly.	Connect the cord properly.
	An incorrect source has been selected.	Select the correct source.
	Muteing is on.	Press MUTING to clear mute.
Sound is emitted from only one speaker.	The speaker cord is not connected correctly.	Connect the cord properly.
	Left-right balance is incorrect.	Adjust balance.
No video.	The video cord is not connected properly.	Connect the cord properly.
	TV input select is incorrect.	Select the correct input.
Cannot play a disc.	A non-NTSC disk has been inserted. The unit and disk region numbers (local numbers) are incompatible.	Replace the disc.
Video and audio are distorted.	The disc is dirty.	Clean the disc.
	A video deck is connected between the center unit and the TV.	Connect the center unit and TV directly.
The edge is missing on the video image.	Initial setup (monitor type) was incorrect.	Run through initial setup again correctly.
	The TV has been set up incorrectly.	Set up the TV correctly.
Continuous static during FM broadcasts.	The received signal is too weak.	Connect an external FM antenna, or contact your dealer.
	The station is too far away.	Select another station.
	The antenna is not connected correctly.	Check the connection.
Unit does not work correctly.	Lightning and electronic noise interferes with operation of the microcomputer.	Switch power off, and remove and re-insert the power plug in the socket.
	Immediately after beginning to heat the room, the unit was moved to a cold location causing condensation to form inside.	Switch power off and leave the unit a few hours before switching power on again.

Specifications

Center unit (XV-THA10)

Audio section

Dynamic Range 97 dB
Total Harmonic Distortion 0.007 %
Output Level 2.0 V RMS

Video section

Horizontal Resolution 500 lines
Signal-to-Noise Ratio 60 dB
Output Level S-video-Y: 1.0 Vp-p/75 ohms
S-video-C: 0.286 Vp-p/75 ohms
Composite: 1.0 Vp-p/75 ohms

Tuner section

Tuning Range FM: 87.5 MHz to 108.0 MHz
AM: 530 kHz to 1,710 kHz
Usable Sensitivity FM: 12.8 dbf (1.2 μ V/75 ohms)
AM loop antenna: 400 μ V/m

Dimensions (W \times H \times D) 403 mm \times 85 mm \times 273.5 mm (15-15/16 inches \times 3-3/8 inches \times 10-13/16 inches)
Mass 5.0 kg (11 lbs)
Power Requirements AC 120 V \sim , 60 Hz
Power Consumption 30 watts (at operation)
3 watts (in standby mode)

Powered Sub-woofer (SP-PWA10)

Amplifier section

Output Level Front/Surround/Center: 20 watts \times 5, 4 ohms, 1 kHz, 0.7 % THD
Woofer: 100 watts, 4 ohms, 100 Hz, 0.7 % THD

Speaker section

Speaker 10 inches (25 cm), bass-reflex
Frequency Range 25 Hz to 200 Hz

Dimensions (W \times H \times D) 280 mm \times 475 mm \times 506 mm (11-1/16 inches \times 18-3/4 inches \times 19-15/16 inches)
Mass 18.8 kg (41.3 lbs)
Power Requirements AC 120 V \sim , 60 Hz
Power Consumption 125 watts

Satellite Speakers (SP-XSA10)

Speakers 7 cm \times 4 cm (2-13/16 inches \times 1-5/8 inches) bass-reflex, Magnetically Shielded
Power Handling Capacity 20 watts
Frequency Range 110 Hz to 20 kHz
Dimensions (W \times H \times D) 62 mm \times 102 mm \times 109 mm (2-1/2 inches \times 4-1/16 inches \times 4-5/16 inches)
Mass 440 g (0.98 lbs)

Center Speaker (SP-XCA10)

Speakers 7 cm \times 4 cm (2-13/16 inches \times 1-5/8 inches) bass-reflex, Magnetically Shielded
Power Handling Capacity 20 watts
Frequency Range 100 Hz to 20 kHz
Dimensions (W \times H \times D) 152 mm \times 62 mm \times 109 mm (6 inches \times 2-1/2 inches \times 4-5/16 inches)
Mass 475 g (1.1 lbs)

Designs & specifications are subject to change without notice.

Appendix A: Table of languages and their abbreviations

When you select the subtitle language or sound, the languages shown below are displayed as abbreviations. To select the desired language, select the abbreviation corresponding the language you want to.

AA	Afar
AB	Abkhazian
AF	Afrikaans
AM	Ameharic
AR	Arabic
AS	Assamese
AY	Aymara
AZ	Azerbaijani
BA	Bashkir
BE	Byelorussian
BG	Bulgarian
BH	Bihari
BI	Bislama
BN	Bengali, Bangla
BO	Tibetan
BR	Breton
CA	Catalan
CO	Corsican
CS	Czech
CY	Welsh
DA	Danish
DZ	Bhutani
EL	Greek
EO	Esperanto
ET	Estonian
EU	Basque
FA	Persian
FI	Finnish
FJ	Fiji
FO	Faroese
FY	Frisian
GA	Irish
GD	Scots Gaelic
GL	Galician
GN	Guarani
GU	Gujarati
HA	Hausa
HI	Hindi
HR	Croatian
HU	Hungarian
HY	Armenian
IA	Interlingua
IE	Interlingue

IK	Inupiak
IN	Indonesian
IS	Icelandic
IW	Hebrew
JI	Yiddish
JW	Javanese
KA	Georgian
KK	Kazakh
KL	Greenlandic
KM	Cambodian
KN	Kannada
KO	Korean (KOR)
KS	Kashmiri
KU	Kurdish
KY	Kirghiz
LA	Latin
LN	Lingala
LO	Laothian
LT	Lithuanian
LV	Latvian, Lettish
MG	Malagasy
MI	Maori
MK	Macedonian
ML	Malayalam
MN	Mongolian
MO	Moldavian
MR	Marathi
MS	Malay (MAY)
MT	Maltese
MY	Burmese
NA	Nauru
NE	Nepali
NL	Dutch
NO	Norwegian
OC	Occitan
OM	(Afan) Oromo
OR	Oriya
PA	Panjabi
PL	Polish
PS	Pashto, Pushto
PT	Portuguese
QU	Quechua
RM	Rhaeto-Romance

RN	Kirundi
RO	Rumanian
RU	Russian
RW	Kinyarwanda
SA	Sanskrit
SD	Sindhi
SG	Sangho
SH	Serbo-Croatian
SI	Singhalese
SK	Slovak
SL	Slovenian
SM	Samoan
SN	Shona
SO	Somali
SQ	Albanian
SR	Serbian
SS	Siswati
ST	Sesotho
SU	Sundanese
SV	Swedish
SW	Swahili
TA	Tamil
TE	Telugu
TG	Tajik
TH	Thai
TI	Tigrinya
TK	Turkmen
TL	Tagalog
TN	Setswana
TO	Tonga
TR	Turkish
TS	Tsonga
TT	Tatar
TW	Twi
UK	Ukrainian
UR	Urdu
UZ	Uzbek
VI	Vietnamese
VO	Volapuk
WO	Wolof
XH	Xhosa
YO	Yoruba
ZU	Zulu

Appendix B: Country code list for parental lock

This list is used for the parental Lock operation. For details, see page 49.

AD	Andorra
AE	United Arab Emirates
AF	Afghanistan
AG	Antigua and Barbuda
AI	Anguilla
AL	Albania
AM	Armenia
AN	Netherlands Antilles
AO	Angola
AQ	Antarctica
AR	Argentina
AS	American Samoa
AT	Austria
AU	Australia
AW	Aruba
AZ	Azerbaijan
BA	Bosnia and Herzegovina
BB	Barbados
BD	Bangladesh
BE	Belgium
BF	Burkina Faso
BG	Bulgaria
BH	Bahrain
BI	Burundi
BJ	Benin
BM	Bermuda
BN	Brunei Darussalam
BO	Bolivia
BR	Brazil
BS	Bahamas
BT	Bhutan
BV	Bouvet Island
BW	Botswana
BY	Belarus
BZ	Belize
CA	Canada
CC	Cocos (Keeling) Islands
CF	Central African Republic
CG	Congo
CH	Switzerland
CI	Côte d'Ivoire
CK	Cook Islands
CL	Chile

CM	Cameroon
CN	China
CO	Colombia
CR	Costa Rica
CU	Cuba
CV	Cape Verde
CX	Christmas Island
CY	Cyprus
CZ	Czech Republic
DE	Germany
DJ	Djibouti
DK	Denmark
DM	Dominica
DO	Dominican Republic
DZ	Algeria
EC	Ecuador
EE	Estonia
EG	Egypt
EH	Western Sahara
ER	Eritrea
ES	Spain
ET	Ethiopia
FI	Finland
FJ	Fiji
FK	Falkland Islands (Malvinas)
FM	Micronesia (Federated States of)
FO	Faroe Islands
FR	France
FX	France, Metropolitan
GA	Gabon
GB	United Kingdom
GD	Grenada
GE	Georgia
GF	French Guiana
GH	Ghana
GI	Gibraltar
GL	Greenland
GM	Gambia
GN	Guinea
GP	Guadeloupe
GQ	Equatorial Guinea

GR	Greece
GS	South Georgia and the South Sandwich Islands
GT	Guatemala
GU	Guam
GW	Guinea-Bissau
GY	Guyana
HK	Hong Kong
HM	Heard Island and McDonald Islands
HN	Honduras
HR	Croatia
HT	Haiti
HU	Hungary
ID	Indonesia
IE	Ireland
IL	Israel
IN	India
IO	British Indian Ocean Territory
IQ	Iraq
IR	Iran (Islamic Republic of)
IS	Iceland
IT	Italy
JM	Jamaica
JO	Jordan
JP	Japan
KE	Kenya
KG	Kyrgyzstan
KH	Cambodia
KI	Kiribati
KM	Comoros
KN	Saint Kitts and Nevis
KP	Korea, Democratic People's Republic of
KR	Korea, Republic of
KW	Kuwait
KY	Cayman Islands
KZ	Kazakhstan
LA	Lao People's Democratic Republic
LB	Lebanon
LC	Saint Lucia

LI	Liechtenstein
LK	Sri Lanka
LR	Liberia
LS	Lesotho
LT	Lithuania
LU	Luxembourg
LV	Latvia
LY	Libyan Arab Jamahiriya
MA	Morocco
MC	Monaco
MD	Moldova, Republic of
MG	Madagascar
MH	Marshall Islands
ML	Mali
MM	Myanmar
MN	Mongolia
MO	Macau
MP	Northern Mariana Islands
MQ	Martinique
MR	Mauritania
MS	Montserrat
MT	Malta
MU	Mauritius
MV	Maldives
MW	Malawi
MX	Mexico
MY	Malaysia
MZ	Mozambique
NA	Namibia
NC	New Caledonia
NE	Niger
NF	Norfolk Island
NG	Nigeria
NI	Nicaragua
NL	Netherlands
NO	Norway
NP	Nepal
NR	Nauru
NU	Niue
NZ	New Zealand
OM	Oman
PA	Panama

PE	Peru
PF	French Polynesia
PG	Papua New Guinea
PH	Philippines
PK	Pakistan
PL	Poland
PM	Saint Pierre and Miquelon
PN	Pitcairn
PR	Puerto Rico
PT	Portugal
PW	Palau
PY	Paraguay
QA	Qatar
RE	Réunion
RO	Romania
RU	Russian Federation
RW	Rwanda
SA	Saudi Arabia
SB	Solomon Islands
SC	Seychelles
SD	Sudan
SE	Sweden
SG	Singapore
SH	Saint Helena
SI	Slovenia
SJ	Svalbard and Jan Mayen
SK	Slovakia
SL	Sierra Leone
SM	San Marino
SN	Senegal
SO	Somalia
SR	Suriname
ST	Sao Tome and Principe
SV	El Salvador
SY	Syrian Arab Republic
SZ	Swaziland
TC	Turks and Caicos Islands
TD	Chad
TF	French Southern Territories
TG	Togo
TH	Thailand

TJ	Tajikistan
TK	Tokelau
TM	Turkmenistan
TN	Tunisia
TO	Tonga
TP	East Timor
TR	Turkey
TT	Trinidad and Tobago
TV	Tuvalu
TW	Taiwan, Province of China
TZ	Tanzania, United Republic of
UA	Ukraine
UG	Uganda
UM	United States Minor Outlying Islands
US	United States
UY	Uruguay
UZ	Uzbekistan
VA	Vatican City State (Holy See)
VC	Saint Vincent and the Grenadines
VE	Venezuela
VG	Virgin Islands (British)
VI	Virgin Islands (U.S.)
VN	Viet Nam
VU	Vanuatu
WF	Wallis and Futuna Islands
WS	Samoa
YE	Yemen
YT	Mayotte
YU	Yugoslavia
ZA	South Africa
ZM	Zambia
ZR	Zaire
ZW	Zimbabwe

HOW TO LOCATE YOUR JVC SERVICE CENTER

TOLL FREE : 1-800-537-5722

<http://www.jvcservice.com>

Dear customer:

In order to receive the most satisfaction from your purchase, read the instruction booklet before operating the unit. In the event that repair is necessary, or for the address nearest your location, please refer to the factory service center list below or within the Continental United States, Call 1-800-537-5722 for your authorized servicer. Remember to retain you Bill of Sale for Warranty Service.

—JVC

JVC SERVICE & ENGINEERING COMPANY OF AMERICA

DIVISION OF JVC AMERICAS CORP.

FACTORY SERVICE CENTER LOCATIONS

10 New Maple Avenue
Pine Brook, NJ 07058-9641
(973)396-1000

1500 Lakes Parkway
Lawrenceville, GA 30243-5857
(770) 339-2582

705 Enterprise Street
Aurora, IL 60504-8149
(630) 851-7855

5665 Corporate Avenue
Cypress, CA 90630-0024
(714) 229-8011

2969 Mapunapuna Place
Honolulu, HI 96819-2040
(808) 833-5828

10700 Hammerly, Suite 110
Houston, TX 77043
(713) 935-9331

13 Cummings Park
Woburn, MA 01801
(781)376-9100

8192 State Road 84
Davie, FL 33324
(954) 472-1960

890 Dubuque Avenue
South San Francisco, CA 94080-1804
(650) 871-2666

Sophisticated electronic products may require occasional service. Just as quality is a keyword in the engineering and production of the wide array of JVC products, service is the key to maintaining the high level of performance for which JVC is world famous. The JVC service and engineering organization stands behind our products.

NATIONAL HEADQUARTERS
JVC SERVICE & ENGINEERING COMPANY OF AMERICA
DIVISION OF JVC AMERICAS CORP.
1700 Valley Road
Wayne, NJ 07470

If you ship the product •••

Pack your JVC unit in the original carton or one of equivalent size and strength. Enclose, with the unit, a letter stating the problem or symptom that exists and also a copy of the receipt or bill of sale you received when you purchased your JVC unit. Print your home return address on the outside and the inside of the carton. Send to the appropriate JVC Factory Service Center as listed above.

Don't service it yourself.

CAUTION

*To prevent electrical shock, do not open the cabinet. No user serviceable parts inside.
Refer servicing to qualified service personnel.*

ACCESSORIES

*To purchase accessories for your JVC product, you may contact your local JVC Dealer.
Or from the 48 Continental United States call toll free : 800-882-2345*



LIMITED WARRANTY

CONSUMER VIDEO 1-90

JVC COMPANY OF AMERICA warrants this product and all parts thereof, except as set forth below ONLY TO THE ORIGINAL PURCHASER AT RETAIL to be FREE FROM DEFECTIVE MATERIAL AND WORKMANSHIP from the date of original retail purchase for the period as shown below. ("The Warranty Period.")

PARTS	LABOR
1 YR	90 DAYS

THIS LIMITED WARRANTY IS VALID ONLY IN THE FIFTY(50) UNITED STATES, THE DISTRICT OF COLUMBIA AND IN COMMONWEALTH OF PUERTO RICO.

WHAT WE WILL DO:

If this product is found to be defective, JVC will repair or replace defective parts at no charge to the original owner. Such repair and replacement services shall be rendered by JVC during normal business hours at JVC authorized service centers. Parts used for replacement are warranted only for the remainder of the Warranty Period. All products and parts thereof may be brought to a JVC authorized service center on a carry-in basis except for Television sets having a screen size 25 inches and above which are covered on an in-home basis.

WHAT YOU MUST DO FOR WARRANTY SERVICE:

Return your product to a JVC authorized service center with a copy of your bill of sale. For your nearest JVC authorized service center, please call toll free: (800)537-5722. If service is not available locally, box the product carefully, preferably in the original carton, and ship, insured, with a copy of your bill of sale plus and letter of explanation of the problem to the nearest JVC Factory Service Center, the name and location of which will be given to you by the toll-free number. If you have any questions concerning your JVC Product, please contact our Customer Relations Department.

WHAT IS NOT COVERED:

This limited warranty provided by JVC does not cover:

1. Products which have been subject to abuse, accident, alteration, modification, tampering, negligence, misuse, faulty installation, lack of reasonable care, or if repaired or serviced by anyone other than a service facility authorized by JVC to render such service, or if affixed to any attachment not provided with the products, or if the model number or serial number has been altered, tampered with, defaced or removed;
2. Initial installation and installation and removal for repair;
3. Operational adjustments covered in the Owner's Manual, normal maintenance, video and audio head cleaning;
4. Damage that occurs in shipment, due to act of God, and cosmetic damage;
5. Signal reception problems and failures due to line power surge;
6. Video Pick-up Tubes/CCD Image Sensor, Cartridge, Stylus(Needle) are covered for 90 days from the date of purchase;
7. Accessories;
8. Batteries (except the Rechargeable Batteries are covered for 90 days from the date of purchase);

There are no express warranties except as listed above.

THE DURATION OF ANY IMPLIED WARRANTIES, INCLUDING THE IMPLIED WARRANTY OF MERCHANTABILITY, IS LIMITED TO THE DURATION OF THE EXPRESS WARRANTY HEREIN.

JVC SHALL NOT BE LIABLE FOR THE LOSS OF USE THE PRODUCT, INCONVENIENCE, LOSS OR ANY OTHER DAMAGES, WHETHER DIRECT, INCIDENTAL OR CONSEQUENTIAL (INCLUDING, WITHOUT LIMITATION, DAMAGE TO TAPES, RECORDS OR DISCS) RESULTING FROM THE USE OF THIS PRODUCT, OR ARISING OUT OF ANY BREACH OF THIS WARRANTY. ALL EXPRESS AND IMPLIED WARRANTIES, INCLUDING THE WARRANTIES OF MERCHANTABILITY AND FITNESS FOR PARTICULAR PURPOSE, ARE LIMITED TO THE WARRANTY PERIOD SET FORTH ABOVE.

Some states do not allow the exclusion of incidental or consequential damages or limitations on how long an implied warranty last, so these limitations or exclusions may not apply to you. This warranty gives you specific legal rights and you may also have other rights which vary from state to state.

JVC COMPANY OF AMERICA
DIVISION OF JVC AMERICAS CORP.

1700 Valley Road
Wayne, NJ 07470

REFURBISHED PRODUCTS CARRY A SEPARATE WARRANTY, THIS WARRANTY DOES NOT APPLY. FOR DETAILS OF REFURBISHED PRODUCT WARRANTY, PLEASE REFER TO THE REFURBISHED PRODUCT WARRANTY INFORMATION PACKAGED WITH EACH REFURBISHED PRODUCT.

For customer use:

Enter below the Model No. and Serial No. which is located either on the rear, bottom or side of the cabinet. Retain this information for future reference.

Model No.: _____

Serial No.: _____

Purchase date: _____

Name of dealer: _____

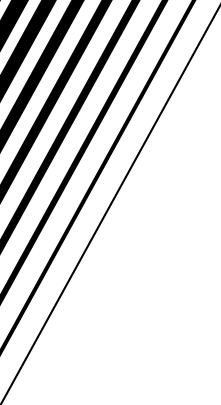

JVC
VICTOR COMPANY OF JAPAN, LIMITED